



Copyright 1995 by SMART Devices Inc.
5945 Peachtree Corners East
Norcross, GA 30071-1337

Table of Contents

SECTION 1	INTRODUCTION	2
SECTION 2	FEATURES.....	2
SECTION 3	CARD DESCRIPTION	3
SECTION 4	INSTALLATION.....	8
	- WIRING HOOKUP INSTRUCTIONS	8
SECTION 5	CALIBRATION	10
	- A CHAIN CALIBRATION.....	10
	- B CHAIN CALIBRATION.....	12
SECTION 6	OPERATING INSTRUCTIONS.....	14
SECTION 7	SCHEMATICS	15

SMART products are designed to deliver unsurpassed quality in workmanship and performance. The following information gives detailed instructions on the installation and operation of the SMART MODIIC processor. We strongly encourage new owners of the MODIIC to thoroughly read this entire manual before placing their new SMART product into service. This will ensure that the MODIIC will be operated properly to give the superior performance that it was designed to deliver.

For service or installation assistance, please call our
Technical Support Department between the hours of
8 a.m-5 p.m. E.S.T., Mon.-Fri.
1-800-45-SMART

LIMITED WARRANTY: SMART products and accessories are warranted against malfunction or failure due to defects in workmanship or materials for a period of one year from the date of shipment. If a problem occurs during the warranty period, the unit will be repaired, or replaced at our option, without charge for materials or labor. If air freight is requested by the dealer, the difference between air and surface charges will be billed to the dealer. This limited warranty does not cover products that have been abused, altered, modified, or operated in other than specified conditions. Prior factory approval is required on all returns. Returned equipment or defective parts must be shipped freight prepaid to us by the dealer or customer.

Our limited warranty does not cover damages resulting from accident, misuse or abuse, lack of responsible care, or failures not attributable to manufacturing defects, except as provided herein. SMART Devices, Inc. makes no warranties, express or implied, including warranties of merchantability or fitness for a particular purpose.

RETURN POLICY: Factory authorization MUST be obtained before returning any product. A 15% restocking charge will be issued on unused equipment (in original box) that is returned for credit. Credit is issued to the dealers account. The credit may be used against future purchases and no cash transactions are offered. All returns must be shipped freight prepaid by the dealer. Equipment returned without a factory RA (Return Authorization) will be refused.

Installation and Service Manual

MODIIC Digital/Optical Cinema Processor

SECTION 1:

INTRODUCTION

The MODIIC Cinema Stereo Processor is a full six channel system featuring the latest technology in optical stereo soundtrack reproduction. This advanced processor comes standard with many features, yet is easy to operate.

The MODIIC has the ability to play spectral recording encoded soundtracks with the built-in SR emulation noise reduction. Digital soundtracks may be processed in six channel mode which includes split surrounds and subwoofer.

Mono soundtracks may be enhanced by using the optional 3-D sound module which may be factory installed or easily added in the future. The 3-D sound module, a design conceived and patented by SRS Labs, produces a realistic stereo effect from monaural soundtracks. SMART Devices, Inc. is the only cinema manufacturer licensed to use this amazing 3-D process in its cinema processors.

Intelligent design, superb sound quality and the many features push the MODIIC processor into a class all its own.

To achieve optimum results from your new MODIIC cinema processor, the theatre engineer installing the system should be totally familiar with all features and adjustments. Careful attention to detail and familiarity with the installation instructions will allow you to offer a system that has a sound quality second to none.

SECTION 2:

FEATURES

FADER CONTROL:

To begin, the MODIIC has one STEREO MASTER FADER that controls the overall playback level for all six channels. This master fader is used as the volume control for all formats except music mode. The master music level control is located behind the front panel on the Format Card.

FORMAT SWITCHING:

The formats available on the MODIIC are Mono, 3-D Mono, Stereo A, Film SR, Digital and Music. All formats may be manually controlled by green pushbuttons on the front panel Format Card. The pushbuttons are lighted with internal LED's to indicate which format is selected. The indicator LED's can be seen from a distance so it is not necessary to be near the processor to verify the status. Format switching is also possible by connecting an automation or remote switch contacts to the FORMAT SELECT terminals on the back of the MODIIC.

SOLAR CELL INPUTS:

The MODIIC has stereo solar cell inputs with electronic changeover for two projectors. Each pair of stereo cell inputs is a quasi-balanced circuit which helps to reduce any interference pickup on the solar cell leads.

DIGITAL INPUTS:

The MODIIC is fully compatible with popular digital formats (i.e. DTS, Dolby Digital, etc.). The MODIIC will easily process the stage, split surround and sub-



woofer channels from an external digital decoder.

MUSIC INPUTS:

The MODIIC is designed to process both stereo and mono music sources from tape, CD or cartridge players. The music processing circuitry contains a simple matrix which derives four channels of sound from a stereo music source.

SURROUND CHANNEL TIME DELAY:

The MODIIC has a digital time delay circuit for the surround channel while playing optical stereo prints. Time delay of the surround channel in optical stereo mode is necessary for two reasons: 1) to mask any front to surround crosstalk and, 2) to synchronize the stage and surround channels to eliminate echo caused by different sound path lengths from the stage and surround speakers.

MAIN OUTPUTS:

The MODIIC has six output channels: LEFT, CENTER, RIGHT, LEFT SURROUND, RIGHT SURROUND AND SUB(woofer). The SUB outputs are balanced with SUB+ and SUB- terminals available. This allows a standard dual channel amplifier to be used in mono bridged mode to feed a subwoofer speaker.

MAIN POWER SUPPLY:

A heavy duty fully-regulated power supply is furnished with the MODIIC processor. This bipolar supply is heavily filtered and supplies ample current for both the positive and negative 20 VDC supplies. This external power supply minimizes the chances of hum pickup when high gain electronic circuits are placed in the same chassis as a power supply. Also, the large power capacity of the supply provides a very "stiff" voltage to all cards in the MODIIC to prevent power sag (momentary drop of the supply output due to heavy loads). This gives excellent transient response and superior stability.

EMERGENCY SOUND BACKUP POWER SUPPLY:

A backup power supply is included with the MODIIC to power the backup preamp built into the MODIIC. This will ensure that you will never lose a show when using the MODIIC processor. The backup supply is located within the main power supply package and delivers about 15 VDC at 100 mA. The backup capability is a standard feature on the MODIIC and is not an extra cost option as it is on other systems.

MODULAR CIRCUITRY:

The MODIIC system is housed in a card cage rack mount assembly. All circuitry in the MODIIC is on individual plug-in cards that allows for easy servicing and future expansion of the system. Each card has its own voltage regulators that stabilize the circuits locally as well as filter unwanted signals that may be present on the main power buses.

SECTION 3:

CARD DESCRIPTION

Test points are included on some cards for the sound engineer to access vital circuit points with his scope or meter. These terminals will accept a meter probe or "alligator" clip. Power must be turned off to the MODIIC before any attempt is made to remove or install a card. If not, then damage to individual circuit cards may result.

FORMAT CARD:

SRS5x390

Audio format selection, both manual and through automation, is controlled by the Format Card. The different format changes available are MONO, 3-D MONO, STEREO A (Dolby type A encoded prints), FILM SR (Dolby type SR encoded prints), DIGITAL and MUSIC. A format is active when the corresponding button is illuminated. The 3-D Mono feature is active when the 3-D Mono button is lit.

MODIIC STEREO PROCES-

Electrical power to the other cards in the system is distributed through this card. The Format Card is where the STEREO MASTER FADER, MUSIC LEVEL control and REMOTE/LOCAL volume control switches are located. The NORMAL/BACKUP switch is also located on this card. Flipping this switch to BACKUP gives an emergency mono center channel. The backup audio level is set by a multi-turn pot on the Mono/Backup Card.

Jumper H3

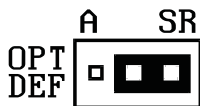

Jumper H2

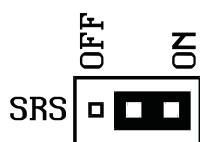

There are two jumpers on the Format Card that select different defaults. Jumper H3 is used to select default optical selection for digital movies (see DEFAULT OPTICAL SELECTION in the WIRING HOOKUP INSTRUCTIONS section). Jumper H2 is used to select whether or not the 3-D feature is on or off for Mono mode when the processor is powered on (see diagram). Units are shipped to power up with the 3-D function active. Either way, the 3-D feature can be activated or disabled by simply pushing the

3-D button on the Format Card. By toggling the 3-D feature on and off, you can hear the difference the 3-D process makes. If the 3-D feature is activated, the button will remain lit all the time, but the 3-D “action” is only used in Mono mode and only if the optional 3-D Mono card has been installed. Without the optional 3-D Mono card, the 3-D button has no effect in Mono mode. In Stereo, Digital and Music modes, the 3-D “action” is not part of the signal processing.

DUAL PROJECTOR PREAMP CARD: MOD4x300

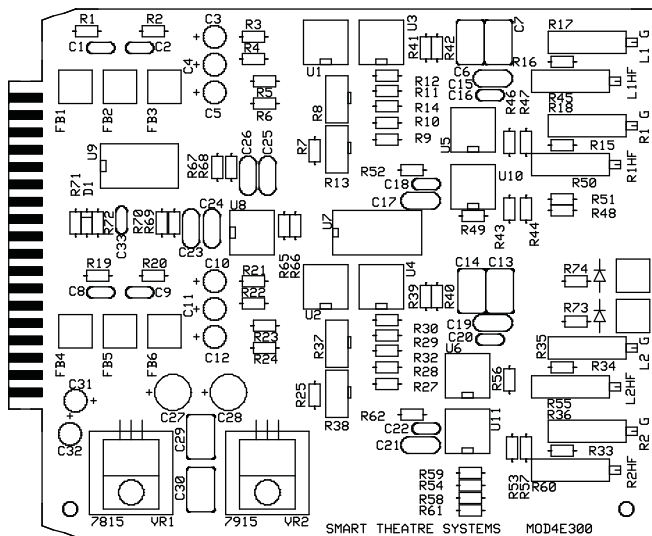

is silk screened to make it easier to see the location of each preamplifier gain and slit-loss correction control pot.

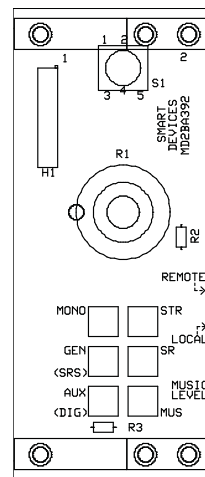
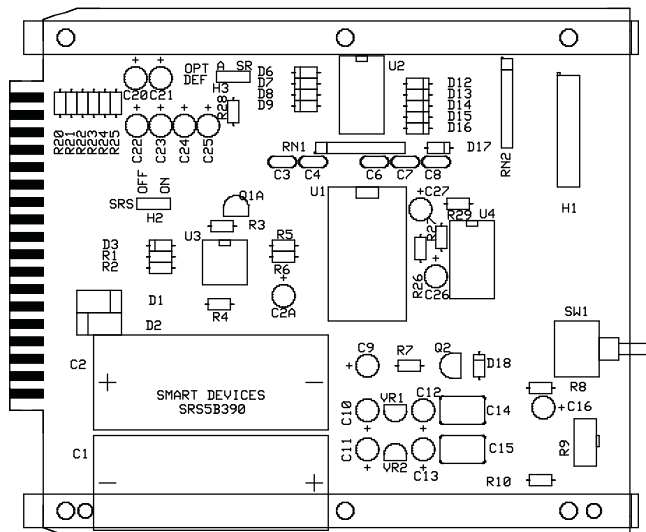

There are two stereo solar cell preamplifiers in the MODIIC. Each preamplifier channel is equipped with slit-loss correction. The Stereo-optical preamplifiers on this card increase the incoming level from the stereo solar cells. Electronic changeover circuitry between stereo pairs is built on the card to allow use in dual projector booths. If the MODIIC is installed in a single projector booth, leave the second projector inputs unconnected.

The Dual Projector Preamp Card has two solar cell preamplifier gain controls (marked L1 G, etc.) and two slit-loss correction controls (marked L1 HF, etc.) for each projector. There is sufficient gain built into the preamps for narrow slit optical sound lenses when the exciter lamp is run at 80% of its rated value. The card

MONO/BACKUP CARD:

MOD2x305

The MONO/BACKUP card provides the necessary frequency response shaping and level shifting to provide a quality mono signal from mono prints. In addition, a special open ended noise reduction circuit called Dynamic Noise Reduction is used to eliminate much of the "hiss" and film scratch noise often present on film.

The MONO/BACKUP card contains the necessary circuitry for the emergency backup system in the event of loss of sound within the MODIIC processor. The multi-turn pot on this card is for setting the emergency backup level.

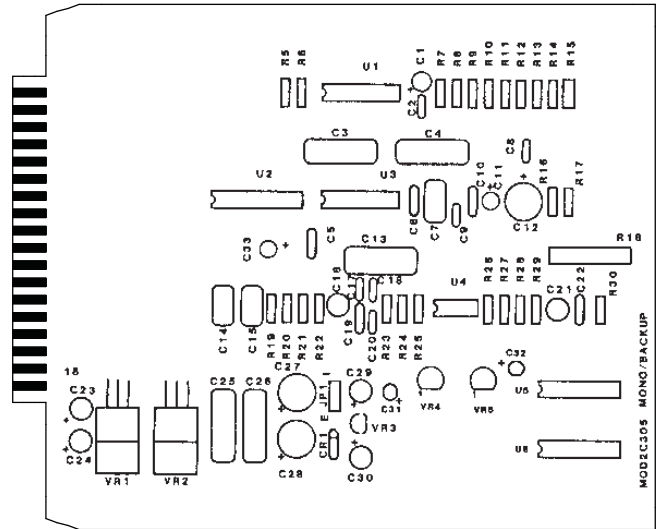

3-D MONO/BACKUP CARD:

SRS5x305

This optional card can be ordered to replace the above Mono/Backup card. The 3-D feature, a design patented by SRS Labs, will generate a very realistic two channel Left-Right stereo sound from any mono print. The MODIIC can be figured to power up with the 3-D feature active for Mono prints (see Format Card description), or it can be activated by simply pushing the 3-D Mono button on the Format card. The 3-D Mono feature is only used in Mono mode. Both the Mono and 3-D Mono lights will be lit when this feature is active.

The 3-D Mono/Backup card also contains the circuitry for the emergency backup system.

METER CARD:

MOD2x335

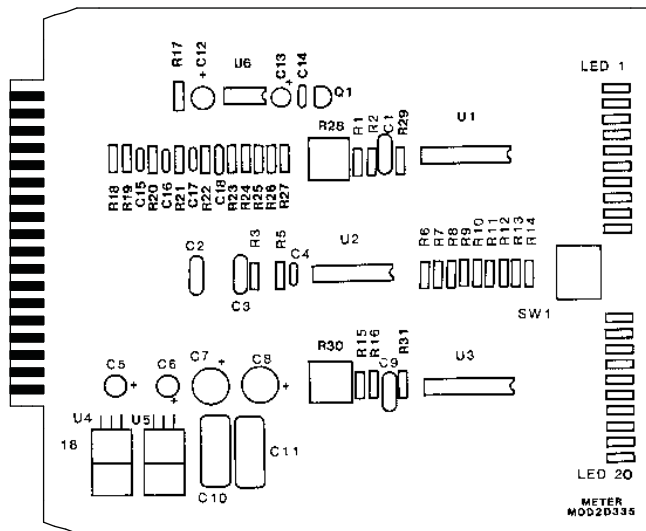

The two LED arrays on this card are used to monitor the levels of various points in the circuitry. These are used during calibration for setting preamp levels and also during normal operation for monitoring other levels. DIP switches on the card select what will be monitored. There are five DIP switches. The top two switches (#5 & #4) control the top LED array. The bottom three DIP switches (#3 - #1) control the bottom LED array. A DIP switch to the right means that it is on, and the corresponding LED array will indicate the selected channel or output. Only two DIP switches should be on at one time, one for the top LED array and one for the bottom LED array. All other DIP switches should be set to off (to the left).

OFF ON		
■	□	5 L PRE
■	□	4 C BUSS
■	□	3 NULL
■	□	2 R PRE
■	□	1 S BUSS

Note: In order to make the overall appearance of the MODIIC look symmetrical as viewed from the front, the LED's on the Meter Card were moved to the solder side. Because of this, the Meter Card will have to be removed anytime it is necessary to remove the left Noise Reduction Card. If not, then the LED's on the Meter Card will block the Noise Reduction Card from being removed.

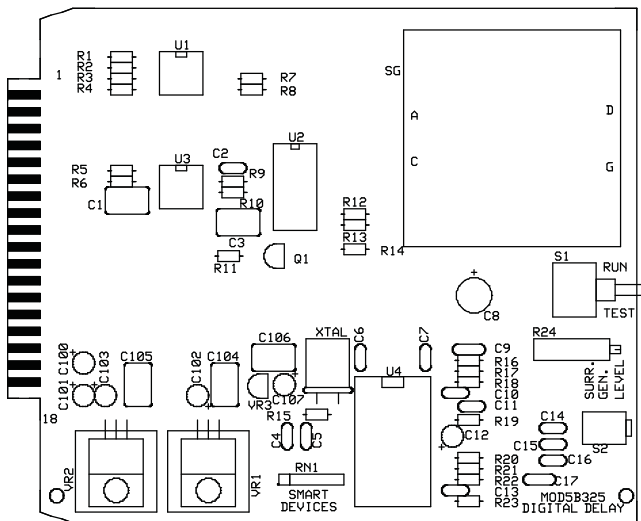

DIGITAL TIME DELAY CARD: MOD5x325

The digital time delay portion of the MODIIC system is contained on this card. The surround channel passes through the time delay whenever any Stereo-Optical format is selected by the operator. Music or digital inputs are NOT time delayed. There is a rotary switch on this card that is used to set the time delay setting. The rotary switch has 16 positions: 0-9 & A-F. Position 0 is 10 milliseconds of delay, which is the minimum delay setting. Each position clockwise adds 10 milliseconds of delay for a maximum setting of 160 milliseconds (position F).

OUTPUT/MUSIC CARD: SRS5x330

Six channels of audio, (Left, Center, Right, Left Surround, Right Surround and Sub), pass through the MASTER VCA (Voltage Controlled Amplifiers) located on the Output/Music Card. The digital inputs also allow for separate Left Surround and Right Surround channels in addition to a separate subwoofer input. The VCAs exhibit very close tracking between channels and are controlled by the STEREO MASTER FADER contained on the Format Card. Music Fade-in and Fade-out, controlled by the automation or front panel format switch, is also on the output card along with a special music matrix to generate a four channel non-sync sound from a standard two channel music tape or CD player.

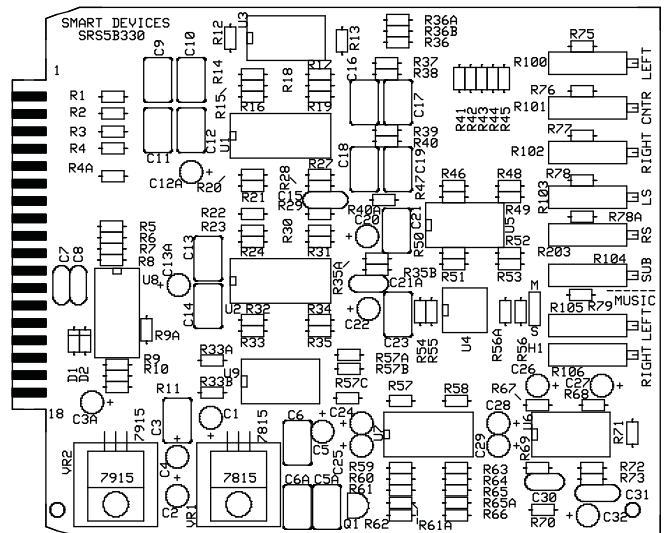

MOTHERBOARD: SRS5x370

SRS5x370

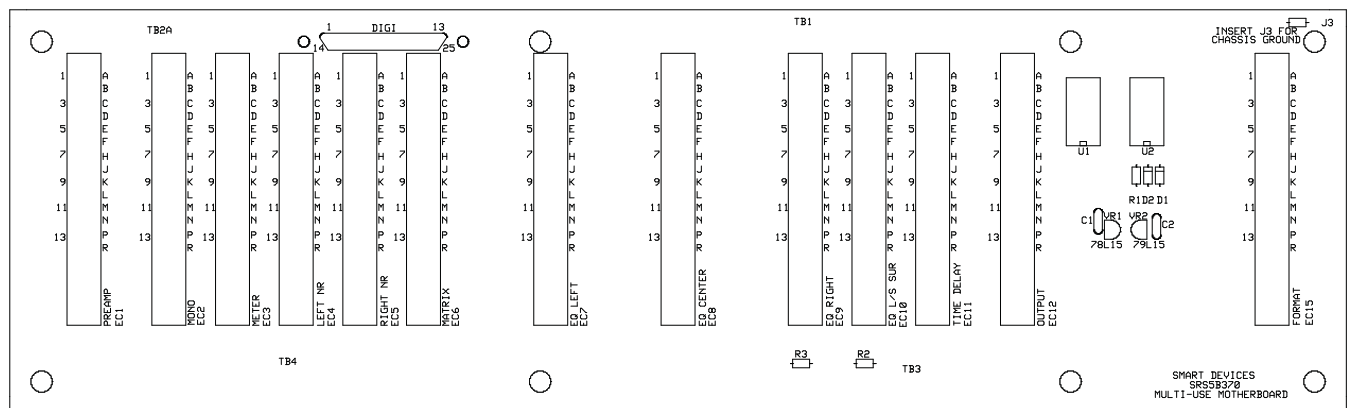

SECTION 4:

INSTALLATION INSTRUCTIONS

PROCESSOR PLACEMENT IN THE RACK:

Before mounting the MODIIC processor in the equipment rack or projector console, be sure to select a well ventilated area that allows cool air to circulate around the individual components. In SMART prewired rack systems, the Power Supply is mounted on the floor of the rack, and the rack-mounted processor is placed at eye level for easy visibility of the system operation status.

Make sure that the processor is not immediately adjacent to hum producing components. Run the factory-supplied power supply wiring harness along the left side of the equipment cabinet (when viewed from the rear) to the MODIIC processor. Dress the wires for appearance and craftsmanship. The wiring harness has a terminal strip that screws onto the back of the MODIIC. Make sure to observe polarity. As you are looking at the back of the MODIIC, the top left terminal strip is where the power supply harness attaches. The power supply wires will exit from the bottom of the terminal strip. The red wire should go to the terminal marked MAIN PS (+), the yellow wire to MAIN PS(-), and the black wire to GND.

The emergency power supply is contained within the Main Power Supply. There is a white wire with a red stripe that is part of the power supply harness and it should be connected to the MODIIC terminal marked BACKUP (+).

Remember to check all connections before applying power to the system. A wire that is reversed could be very destructive to the system.

WIRING HOOKUP INSTRUCTIONS:

EASY HOOKUP:

All connections are made to rear of the MODIIC via terminal strips. Inputs, Outputs, Power and Control connections are carefully laid out in groups. Make sure each group has good separation between low-level and high-level signals.

SOLAR CELL HOOKUP:

Using two-conductor shielded cable, connect the wire from the left solar cell (red) to the corresponding LEFT projector 1 input terminal of the MODIIC. Connect the

wire from the right solar cell (green) to the RIGHT projector 1 input terminal. The common solar cell lead (black) should be connected to the NEUTRAL projector 1 input terminal, and the shield of the cables should be connected to a GROUND terminal. Be sure to cut off the shield at the projector end so that a ground loop is not created. Only the shields on the MODIIC end of the cable should be grounded. It is good practice to tape or shrink wrap the end of the shielded cable at the sound head to prevent any stray shield wires from grounding out to the sound head case.

If you have a second projector, repeat the above steps except hook your solar cell wires to the projector 2 inputs.

DOUBLE CHECK your work to see that the solar cell leads arrive at the proper terminals. A reversal of leads will cause very strange results. You may hear the center channel information through the surround speakers, the surround through the stage, and the left channel out of phase with the right. This is a common error, so verify correct wiring before proceeding.

CHANGEOVER WIRING OF DUAL PROJECTOR PREAMPS:

Changeover between projectors is done electronically in the MODIIC. This necessitates that BOTH exciter lamps be lit at the same time. No exciter light changeover is provided in the unit. An exciter light changeover has at least 3 dB more circuit noise than an electronic changeover and is NOT recommended in high quality systems.

Projector changeover is accomplished by using only a single pair of wires and either a manual switch or relay contacts in the automation system. A relay closure in the automation equipment will execute a changeover by grounding the CHNG-OVER terminal. Run a 2-conductor shielded cable to the "dry" contacts of the automation projector changeover relay. On the other end, connect one wire to the CHNG-OVER terminal on the MODIIC. Ground the other wire to the nearest ground terminal on the MODIIC. Connect the shield of the wire, on the MODIIC end, to a ground terminal. Cut off the shield on the automation end. When the automation relay closes, PROJECTOR TWO of the MODIIC will be "enabled," and the first pair of stereo preamplifiers (PROJ ONE) will be "disabled." Releasing the relay will cause the reverse action to occur. In other words, PROJ ONE is always ON until the CHNG-OVER terminal is grounded. The CHNG-OVER terminal must be held low to activate PROJ 2. It is not a pulse input.

MUSIC INPUT:

The non-sync music inputs for the MODIIC feature a special music matrix decoder that separates in-phase and out-of-phase signals on a standard two channel recording (CD player or tape) and creates four channels of auditorium music. Connect your stereo music source to the MUSIC LEFT and MUSIC RIGHT inputs on the back of the MODIIC.

Occasionally, a theatre may use a monaural sound player such as a background music cartridge player that does not have stereo capabilities. A jumper on the OUTPUT CARD in the MODIIC is moved to the MONO position for this use. The music source should then be connected to both LEFT and RIGHT MUSIC inputs. Music will appear on all stage channel and surround speakers when mono material is feeding the sound system.

FORMAT SELECT TERMINALS:

A momentary ground contact to one of the FORMAT SELECT inputs on the rear of the MODIIC will switch the processor to any desired format, including music. When the MODIIC is in music mode and any one of the film formats are pulsed, the film sound will appear at the main outputs, and the music will slowly fade out. While the processor is in one of the film formats and the music terminal is pulsed, the MODIIC will fade from the film mode to music.

Note: The MODIIC powers up in Music mode.

DIGITAL INPUTS:

The MODIIC system has six inputs (Left, Center, Right, Left Surround, Right Surround and Sub) via a DB25 input connector marked DIGITAL INPUTS that can be used to process the outputs from an external digital decoder (i.e. DTS, Dolby Digital). The DIGITAL INPUTS accept any high level multi-channel source. The audio signals are processed through the individ-

ual equalizers, Output Card and Master VCA circuit before they appear at the Main Outputs. These signals do not pass through the Matrix or Time Delay circuits. See the REAR CHASSIS DB25 SECTION for specific pinout designation.

Another application of the Digital Input terminals is for external sync sources. Sound-Interlock from a 35 mm reproducer or a single 16 mm projector may be fed into the DIGITAL INPUTS and selected with the front panel DIGITAL program switch on the MODIIC Format Card.

REAR CHASSIS DB25 CONNECTOR:

The computer-type DB25 connector marked DIGITAL INPUTS on the back of the processor is for an external digital decoder. SMART provides the proper cables for the different digital decoders available on the market. See below for specific pinout configuration.

The DIGITAL DB25 inputs

- Pin 1 Left
- Pin 3 Center
- Pin 5 Right
- Pin 6 Left Surr.
- Pin 7 Right Surr.
- Pin 8 Sub
- Pin 12 Digital Select
- Pin 13 Stereo A / Stereo SR Default*
- Pin 14-25 Ground

*see Default Optical Selection below

DEFAULT OPTICAL SELECTION:

External digital decoders available on the market have a function that instructs the processor to switch to an optical format in the event that the digital decoder fails or loses time code. When this happens, the digital decoder will pulse a special terminal to ground to alert the processor to switch to the optical format.

On the MODIIC Digital DB25 input connector, this ter-

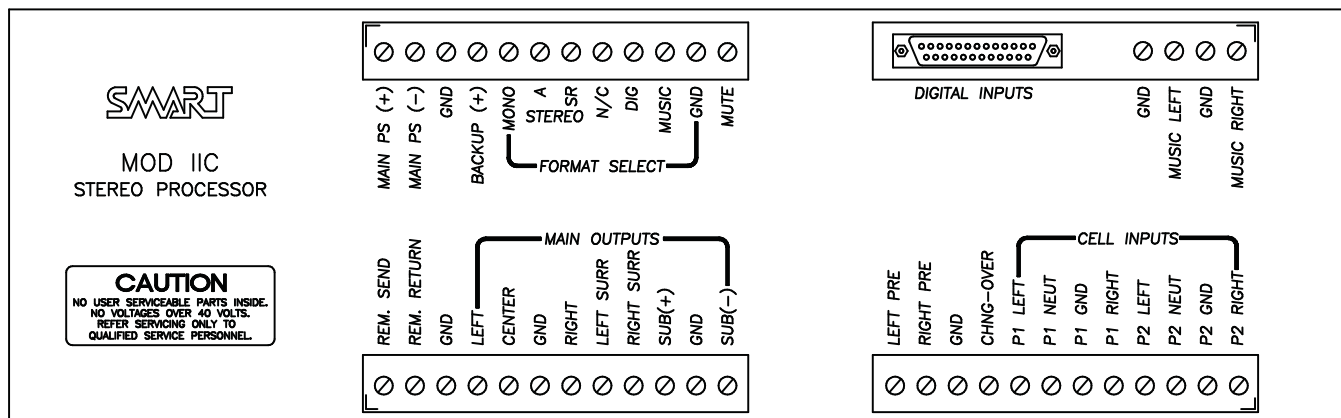

minimal is the Stereo A / Stereo SR pin (see above). The MODIIC will switch to either Stereo A or Stereo SR depending on the location of a jumper (H3) located on the Format Card.

The MODIIC is shipped to default to Stereo A in the event of a digital decoder problem. In this default mode, jumper H3 on the Format Card jumpers the center pin to the "A" pin. For a default setting of Stereo SR, you must move the H3 jumper to jump the center pin to the "SR" pin. The factory default setting of Stereo A should be adequate for most theatres. However, if Stereo SR default is desired, then the Format Card must be removed to access the H3 jumper. Make sure power is removed from the system before removing any card or plugging one in.

OUTPUTS:

The MAIN OUTPUTS are labeled LEFT, CENTER, RIGHT, LEFT SURROUND, RIGHT SURROUND, SUB+ and SUB-. Shielded cable should be run between these terminals and the next piece of equipment in the sound system (equalizer, amplifier, etc.). Convenient GROUND (GND) terminals are provided near the outputs. A balanced subwoofer output is available on the MODIIC to provide an easy means to mono bridge the sub amplifier. The subbass output may also be operated in an unbalanced configuration by connecting to the SUB+ terminal and GROUND.

MUTING FUNCTION:

A convenient MUTE terminal on the back of the MODIIC allows all output channels of the MODIIC to be silenced whenever this terminal is grounded.

REMOTE FADER OPERATION:

The volume control of the MODIIC can be operated remotely at another location, independent of the STEREO MASTER FADER. This can be accomplished by adding a remote, linear taper 10k ohm pot (to act as a volume control) between the REM SEND and GROUND terminals on the back of the MODIIC. Connect the wiper of the remote pot to the REM RETURN terminal.

The toggle switch on the right hand side of the Format Card, labeled REMOTE/LOCAL, allows the operator to select either local or remote volume control of the MODIIC. This switch is easily accessible by removing the four thumb screws that attach the front plate to the MODIIC.

Note: Remote operation is for film formats only, and will not affect the music level.

SECTION 5:

CALIBRATION

For more detailed information about setting up SMART processors, see the *Theatre Sound for SMART Systems* guide. The Sound Systems should be turned on for at least one hour before alignment. All doors should be closed and the exhaust fan should be running if the MODIIC is placed in an equipment rack. Note: Before plugging or unplugging cards in the MODIIC during calibration, be certain power is removed from the MODIIC. Otherwise, damage to cards or the processor may result!

EQUIPMENT REQUIRED:

Sound Pressure level meter, real time analyzer (RTA) with a calibrated microphone, dual trace oscilloscope, multimeter, a tuning wand and appropriate test loops.

A CHAIN CALIBRATION

The A chain is usually considered to be the signal path originating from the solar cell and continuing to the processor's master fader. This signal path includes the preamp, noise reduction and matrix stages.

PRELIMINARY:

1. Clean soundhead optics, exciter lamp, optical lens and solar cell before attempting a soundhead alignment.
2. Set exciter lamp voltage for at least 80% of rated voltage.
 - BXM 9 volt 4 amp — 7.2 volts
 - BXN 10 volt 5 amp — 8 volts
 - Most foreign 6.3 volt 4 amp — 5 volts
3. Make sure film/cell spacing is approximately 1 mm with the slit image striking the top one-third of solar cell.
4. Connect oscilloscope and real time analyzer to the Left and Right Preamp outputs on the rear terminals of the MODIIC (marked LEFT PRE & RIGHT PRE).
5. Locate the Gain and Slit Loss controls on the Preamp Card. Turn Gain controls fully clockwise. Turn Slit Loss controls fully counterclockwise.
6. Turn the STEREO MASTER FADER all the way down to avoid excessive noises in the auditorium for the next steps.

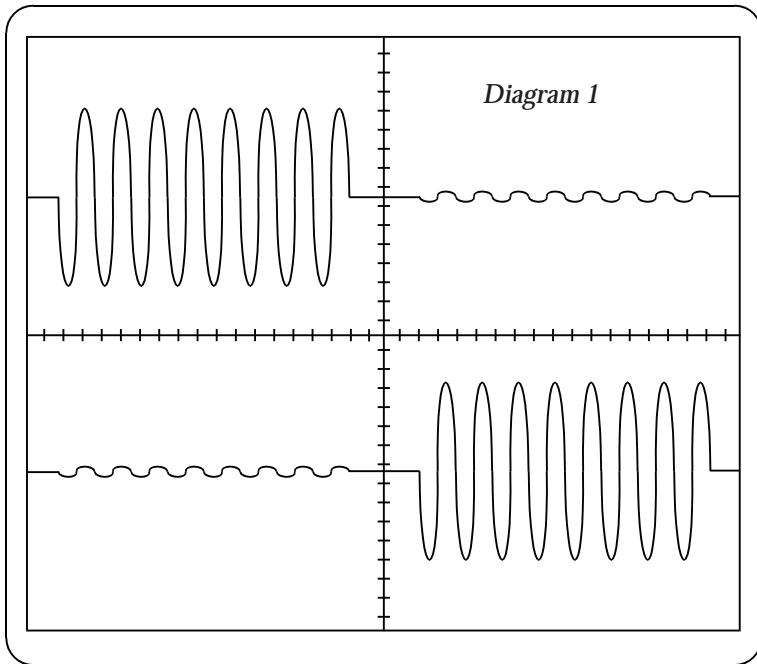

Low crosstalk between channels

SOUNDHEAD ALIGNMENT:

1. Play a S.M.P.T.E. Buzz Track loop. Adjust the lateral film guide assembly or exciter lamp assembly. Monitor the preamp signals with the oscilloscope. Adjust for minimum signal on the left and right channels. Refer to specific instructions in the projector soundhead manual. Minor variations in alignment procedure depend on the individual mechanical design of the soundhead.

2. Play CAT.# 97 Stereo Cell Alignment Film. Move

Diagram 2

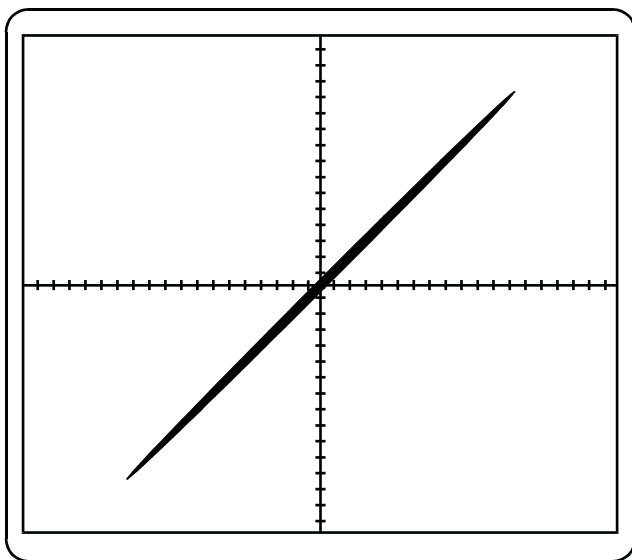

solar cell laterally and vertically until you have achieved minimum crosstalk between channels (see diagram 1).

3. Repeat steps 1 and 2 until no further improvement can be obtained.

4. Play Pink Noise side of CAT.# 69 Test Film. Switch oscilloscope to X/Y Mode. Adjust soundhead optical lens azimuth for narrowest diagonal trace (see diagram 2). Observe the real time analyzer and focus the lens for maximum high frequency output while maintaining the best azimuth. This is not easy, but it is one of the most critical adjustments affecting the overall system performance and is often not done as well as it should be.

5. Adjust the vertical and lateral alignment of the EXCITER LAMP for maximum output on both channels. This is especially critical with a narrow slit optical lens because there is a much smaller "window" for the light to pass through.

6. Check the high frequency output on both channels. Make sure the response is the same on both channels. With a narrow slit optical lens, the response should be flat within ± 3 dB to about 12 kHz with NO slit loss correction. If not, this MUST be corrected before proceeding with the next steps. It is not permissible to use slit loss correction to correct poor high frequency response caused by misalignment of the optical soundhead. An EXCITER LAMP out of alignment, the barrel of the optical lens crooked, or oil in the optical lens will all affect output and balance.

SLIT LOSS CORRECTION:

Run the Pink Noise side of the CAT. # 69 Test Film. Observe the frequency response on your RTA which should be still connected to the preamp testpoints. Adjust the left and right slit loss correction trimpots on the PREAMP CARD for optimum flat high frequency response. Do not over adjust the slit loss correction in an effort to obtain extended response. This will result in an undesirable frequency response peak.

Note: While adjusting the slit loss correction, aim for as flat a high frequency response as possible. If one of the preamp channels is slightly worse than the other, then adjust the better responding preamp to match the lesser. This will ensure that the matrix steering in the MODIIC will be as accurate as possible.

OPTICAL PREAMP CALIBRATION:

Run a Dolby CAT. # 69 Test Film, Dolby tone side.

MODIIC STEREO PROCESSOR

Locate the Meter Card and set DIP switches #2 and #5 ON (to the right). All other DIP switches should be off. This causes the top LED array to indicate the left channel preamp level, and the bottom LED array the right channel preamp level.

Make sure you are changed over to the correct projector by observing the CHANGE OVER LED's on the Preamp Card. The top LED is Projector 1.

Turn Projector 1 left channel gain control counter-clockwise until the bottom red LED on the top LED array of the Meter Card just blinks out. All green and yellow LED's on the Meter Card should be lit (on the channel you are adjusting).

Repeat the above procedure for the right channel gain control, using the bottom LED array on the Meter Card as a reference.

You can verify that the LED meters are indicating correctly by connecting an AC voltmeter to the LEFT PRE and RIGHT PRE terminals on the rear panel. You should read between 700 to 714 mV AC at these test points.

If this is a two projector system, change over from Projector 1 to Projector 2 by grounding the CHNG-OVER terminal on the back panel. Then repeat the above A chain calibration steps for the second projector.

SURROUND NULL:

Turn off switch #2 (to the left) on the Meter Card. Now, turn on switch #3 (to the right) which makes the bottom LED array the NULL reading. Select the STEREO A button on the Format Card. Adjust the SURROUND NULL trimpot on the Matrix Card until a minimum number of LED's are lit on the bottom LED array of the Meter Card. A good null is when only two or three LED's are lit. This setting is crucial because a good null means minimum crosstalk in the surround channel. For normal operation, leave switches #2 & #5 on (to the right), and all others off.

The most likely cause of difficulty in obtaining a good null is the azimuth alignment of the optical sound lens. This is a very critical soundhead adjustment if you expect to get the best performance.

BYPASS:

Run a film soundtrack. Listen to the CENTER channel on the booth monitor. Switch from Normal to Backup (the switch on the Format Card) and adjust the backup level pot on the Mono Card to achieve equal levels

while switching from Normal mode to Backup mode. *This completes the A Chain and BYPASS calibrations.*

B CHAIN CALIBRATION

The B chain calibration is generally considered to be the signal path from the processor's master fader to the speakers. This signal path includes the equalizers and output stage. Before continuing with the B Chain calibration, check the wiring of all auditorium speakers to make sure the phase is correct. The "SMART EZ Phase Checker" is a perfect unit for verifying proper phase of speakers.

PRELIMINARY:

It is desirable to have a SMART PINK NOISE GENERATOR CARD and an EXTENDER CARD for performing the calibration and testing of the MODIIC. Note: Make sure the SMART Pink Noise Generator Card has the following minor modification: There must be a jumper wire between pins 4 & 5 of the edge connector as viewed from the component side. This allows the Surround switch to simultaneously feed pink noise to both Left and Right Surround channels. A future version of the Pink Noise Generator card will have separate Left and Right Surround switches.

The PINK NOISE card may be plugged directly in without the extender card if the metal cover is removed from the Pink Noise Card. However, it is easier if the extender card is used with the PINK NOISE card. The PINK NOISE card plugs into the MATRIX CARD position for setting house EQ levels and sub-bass levels. The PINK NOISE CARD has seven switches. Make sure the bottom switch is in the NORMAL position. The top six switches are used to turn individual channels on and off. These channel

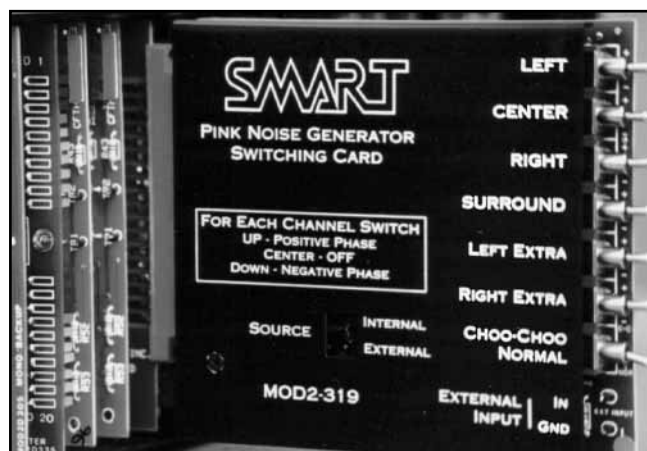

The optional extender card can be used with the Pink Noise Card to calibrate the MODIIC. This allows easier access to the Pink Noise Card.

switches are three position, with center position being off, the top position giving an in-phase signal and the bottom position giving an out-of-phase signal. There is a built-in high quality pink noise source which feeds these switches.

If a Pink Noise Card is not available for the MODIIC calibration, then an external pink noise source may be used instead. Feed the external pink noise source into the DIGITAL INPUTS on the rear DB25 input connector of the MODIIC for the following checks. Set the pink noise source level for .55 volts RMS. You must use an analog meter to measure this voltage level.

Special Note: If you will be installing an external digital decoder, do so AFTER setting house levels. See the DIGITAL LEVEL SETTINGS at the end of the B CHAIN CALIBRATION section for more information.

For the following procedures, select STEREO A by pushing the appropriate button on the Format Card. Also, set the STEREO MASTER FADER to the one o'clock position.



The optional 1/3 octave EQ card

EQUALIZATION AND HOUSE LEVELS:

The equalizers are normally shipped with the individual trimpots set for a flat frequency response. The optional 1/3 octave equalizers used for the stage channels are capable of cutting and boosting each frequency

band ± 10 dB. The individual trimpots are single turn types, with the mid position of each pot being flat (unity gain).

On the standard one octave equalizer cards, all frequencies are cut and boost ± 10 dB with single turn trimpots also.

Remove the MATRIX CARD from its slot and set it aside. Plug the PINK NOISE CARD into the MATRIX CARD slot. Make sure the NORMAL/CHOO-CHOO switch is in the NORMAL position. Turn on the appropriate switch on the PINK NOISE CARD for the channel you wish to equalize. Perform the equalization (see diagram 3) and then adjust the output trim-

ISO Cinema playback standard states that 1/3 octave bands should be tuned for flat response to 2 kHz, with a 3 dB/octave rolloff above 2K.

Diagram 3

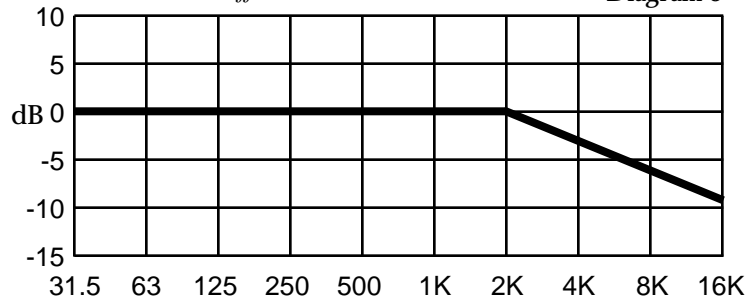

pot on the OUTPUT/MUSIC CARD so that 79 dBC spl is measured in the auditorium. Do this for the five main channels (Left, Center, Right, Left Surround & Right Surround). If more gain is needed, then the gain pot on the stage EQs can be used which gives an additional 6 dB of gain. However, do not boost the gain on the EQ cards unless it is absolutely necessary.

The optional 1/3 octave stage channel equalizers in the MODIIC allow the same tuning results obtained in professional room tuning filter sets used in high-end sound playback applications. Sound contractors learned, a long time ago, that boosting frequency bands adjacent to bands that are cut introduce a phase shift that the ear is very sensitive to. Although the test instruments show a nice curve, the sound has a coloration that is not natural. For this reason, we encourage you to apply the minimum amount of boost and cut whenever needed. Never over-equalize the system. All frequencies may be cut and boosted by as much as 7 dB in each of the 1/3 octave bands without creating the above problems. The use of bass and treble controls on the equalizer has also been avoided to further minimize phase shift. Each filter section uses a single turn trimpot for adjustment. The equalizers are factory set for a flat response during final QC test.

Before attempting to equalize be sure the stage speaker connections are properly polarized, the polarity of the components in each speaker system is correct, and the speaker devices are mechanically aligned according to the manufacturer's recommendations.

Remember that equalizers are used to tune the room, NOT to correct poor speaker installation and alignment.

SUB-BASS LEVELS:

With the Pink Noise Generator Card plugged into the Matrix Card slot, turn on the LEFT and RIGHT pink noise switches. Turn off the Left and Right channel amplifiers to prevent sound from the Left and Right stage speakers from affecting this adjustment. Adjust the SUB LEVEL trimpot on the Output Card for 90

MODIIC STEREO PROCESSOR

dBc spl from the subwoofer. The installer may wish to adjust for another level, depending on the amount of subwoofer desired. Turn the Left and Right channel amplifiers back on.

An alternative procedure is to turn on the LEFT and RIGHT pink noise switches and adjust the SUB LEVEL on the Output Card to "level out" the lower end frequencies as viewed on an RTA set up in the auditorium. Do not turn off the Left and Right channel amplifiers for the alternative method.

Plug the MATRIX Card back into its slot.

OPTIONAL 3-D MONO FUNCTION:

No adjustments are necessary for units equipped with the optional 3-D Mono/Backup Card.

MUSIC LEVELS:

Set the MUSIC LEVEL control, located behind the front panel on the right side of the Format Card, two-thirds up from its counterclockwise position. Select Music mode and turn on the music source that is feeding the MODIIC. Turn the left and right music level trimpots on the Output/Music Card to obtain a normal house level. These trimpots are factory set and may not need adjustment. DO NOT TURN THESE UP TOO HIGH as music-to-film crosstalk may occur. Adjust the trimpots so that right and left music are set to the same level. A way to accomplish this is to play a stereo music selection with a good vocal track and adjust either the left or right music trimpots for minimum vocals in the surround channel.

The music circuit in the MODIIC has a simple matrix which generates four channels of music from any 2-channel stereo music source.

TIME DELAY:

Locate the 325 DIGITAL TIME DELAY Card. The bottom of this card has a rotary switch. Each position clockwise on the rotary switch equals 10 mSec (milliseconds) of delay. Position 0 is the minimum delay setting which equals 10 mSec of delay. Position 1 produces a total of 20 mSec of delay, position 2, 30 mSec, etc. The maximum amount of delay possible is 160 mSec. Measure the distance in feet from the ideal seat (which is usually 2/3 of the way back from the stage speakers, centered side to side) to the stage speakers. Now measure the dis-

POSITION	DELAY mSec
0	10
1	20
2	30
3	40
4	50
5	60
6	70
7	80
8	90
9	100
A	110
B	120
C	130
D	140
E	150
F	160

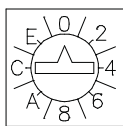

tance from the ideal seat to the nearest surround speaker. Subtract the two measurements. Now add 20 to this number to get the delay (in milliseconds) required in the auditorium. Set the rotary switch to the nearest setting in milliseconds.

DIGITAL LEVEL SETTINGS:

Incoming signals feeding the DIGITAL INPUT terminals MUST be trimmed externally to match levels from the Stereo-Optical signals. These adjustments can be made at the output of the external digital decoder or interlock audio tape machine (see manufacturer's manual). Make sure that all other B-chain calibration adjustments have been made prior to adjusting the digital levels (see special note in the PRELIMINARY section of the B CHAIN CALIBRATION).

This completes the B chain calibration.

SECTION 6:

OPERATING INSTRUCTIONS

The MODIIC system is one of the easiest systems to operate. The Manager/Operator of the sound booth should review the operation instructions to assure that emergency functions are also understood, should they ever be needed.

TURNING ON THE SYSTEM:

The sound engineer who installed the sound system has provided a way to apply power to the system through a master power switch or circuit breaker. Also, several of the individual components in the equipment rack have their own power switches. Become familiar with all switches or breakers that control power to the sound equipment.

If the components are normally turned on individually, it is important that the processing components are turned on first and the power amplifiers are turned on last. This will allow time for the low level circuits to stabilize so that the power amplifiers will not pass a "turn-on thump" to the auditorium speakers. Repeat in reverse order when turning off the system.

MUSIC SELECTION:

It is likely that the sound system will be turned on before the arrival of the first audience of the day. The MODIIC powers up in Music mode. If the music player (CD player or tape machine) is running, music will be heard in the auditorium and on the booth monitor. Music may also be selected by pressing the front panel

MUSIC button.

PROGRAM SELECTION:

The automation should be set to select the proper formats when needed. However, any format may be overridden by simply pushing one of the Format buttons located on the front of the MODIIC.

STEREO MASTER FADER:

This control is located on the MODIIC Format Card and is used to set the system level for any film format, but not for music level. The system was calibrated with the STEREO MASTER FADER at the one o'clock position, which is where most prints will play at a normal level.

MUSIC LEVEL CONTROL:

The music level should have been preset by the installer of the sound system. However, if any change in music level is desired then the MUSIC LEVEL control can be turned to change the overall volume level. This trimpot is located on the lower right side of the Format Card. The four screws holding the front panel of the MODIIC must be removed to access the MUSIC LEVEL control.

EMERGENCY BYPASS SWITCH:

The MODIIC contains a backup system that will keep the show sound on the screen in the event of a failure of the processor. This special circuitry is located on the Mono card in the main card cage unit and is activated by the NORMAL-BACKUP switch located just above the Format pushbuttons.

SECTION 7:

SCHEMATICS

Format Card (SRS5x390) – page 16

Pushbutton Card (MD2BX392) – page 17

Dual Projector Preamp Card (MOD4x300) – page 18

Mono/Backup Card (MOD2x305) – page 19

Meter Card (MOD2x335) – page 20

Noise Reduction Card (MD2Bx374) – page 21

Matrix Card (MOD4x317) – page 22

Optional 1/3 Octave EQ Card (MOD4x320&321) – page 23-24

One Octave EQ Card (MOD4x324) – page 25

Digital Time Delay Card (MOD5x325) – page 26

Output/Music Card (SRS5x330) – page 27

MODIIC Power Supply (RPS-20) – page 28

3-D Mono Card (SRS5x305) – page xx



The Normal/Backup switch and Stereo Master Fader