



**MODEL DA20
DIGITAL FILM
SOUND PROCESSOR
Installation Manual**

ISSUE 6

Part No. 91341

INSTALLATION MANUAL

FOR

MODEL DA20 DIGITAL FILM SOUND PROCESSOR

Dolby Laboratories Incorporated

U.S.A. 100 Potrero Avenue, San Francisco, CA 94103
Tel: 415-558-0200; Fax: 415-863-1373

U.K. Wootton Bassett, Wiltshire SN4 8QJ
Tel: +44 (0) 1793 842100; Fax: +44 (0) 1793 842101

www.dolby.com

WARRANTY INFORMATION-USA: Warranty on the product covered by this manual is subject to the limitations and disclaimers set forth in the warranty disclaimer originally shipped with the product and also printed on the back of the invoice.

Digital decoding covered by the following U.S. patents: 4,790,016, 4,914,701, 4,799,260 4,941,177, 5,109,417, 5,142,656, 5,230,038, 5,274,740, 5,297,236, 5,357,594, 5,463,424, 5,583,962, 5,608,805, and other worldwide patents granted and pending.

All requests for repairs or information should include the unit serial number to assure rapid service.

Dolby and the double-D symbol are registered trademarks of Dolby Laboratories.

TABLE OF CONTENTS

INTRODUCTION

Specifications	iii
About This Manual	iv

SECTION 1 EQUIPMENT REQUIRED/POWER REQUIREMENTS

1.1 Equipment Required	1-1
1.2 Power Requirements	1-1
1.3 Regulatory Notices	1-2

SECTION 2 INITIAL SETUP AND INSTALLATION

2.1 Mounting the Digital Soundhead	2-1
2.2 Electrical Connections to the Digital Soundhead	2-4
2.3 Making a Custom Video Cable	2-5
2.4 Connection to Motor Start Relays—For 2 Projector Installations	2-9
2.5 Connection to Dolby Cinema Processors	2-10
2.5.1 Installation of DA20 with CP55	2-10
2.5.2 Installation of DA20 with CP65	2-40
2.5.3 Installation of DA20 with CP200	2-43
2.5.4 Installation of DA20 with CP45	2-82
2.5.5 Installation of DA20 with CP500	2-85

SECTION 3 CAT. NO. 700 DIGITAL SOUNDHEAD ALIGNMENT

3.1 Cat. No.700 Digital Soundhead Alignment	3-1
3.2 Test Setup with Oscilloscope	3-1
3.3 Focus Adjustment	3-2
3.4 Exciter Lamp Level Confirmation and Adjustment	3-3
3.5 Film Path Alignment	3-3
3.6 Optical Alignment	3-4

SECTION 4 MODEL DA20 ALIGNMENT

4.1 Cinema Processor Type Selection	4-1
4.2 Digital Soundhead Delay Adjustment	4-2
4.3 Digital Surround Delay Adjustment	4-3

SECTION 5 THEORY OF OPERATION

5.1 DA20 Basic Functions	5-1
5.2 Discussion of Changeover Technique	5-3
5.3 Format Control	5-3
5.4 Auxiliary Data Channel	5-4
5.5 Dolby Digital Decoder Block Diagram	5-5

SECTION 6 OPERATING INSTRUCTIONS

6.1 How to Identify Sound Tracks on Prints	6-1
6.2 Film Threading	6-1
6.3 Displays	6-2
6.4 Format Control and Auto Digital Modes	6-4
6.5 Auxiliary Data Channel	6-7
6.6 Two Projector Changeover Operation	6-7
6.7 Operation With An Automation System	6-8

SECTION 7 MAINTENANCE AND ADJUSTMENTS

7.1 Digital Soundhead Maintenance 7-1
7.2 Print Cleanliness 7-2
7.3 Adjustments 7-2

SECTION 8 UNIT SERVICING / IN CASE OF DIFFICULTY

8.1 Troubleshooting During the Show 8-1
8.2 Problem Identification 8-2
8.3 Determining Software Revision No. 8-5
8.4 Starting and Program Loading 8-6

SPECIFICATIONS

DA20 Digital Film Sound Adaptor

Inputs

Digital Soundhead

Inputs for up to two Dolby Cat. No.699/700 Digital Soundheads or comparable inboard readers.

Audio

For use with Dolby CP200 Cinema Processors (separate input not required for CP65 and CP55).

Motor Start

Two control inputs detect motor start signals from projectors 1 and 2.

Projector Changeover

Single input. Ground to select projector 2, open for projector 1.

Outputs

Audio

Left, Center, Right, Left Surround, Right Surround, Mono Surround and Subwoofer (L, C, R, LS, RS, S and SW).

Auxiliary Data Port

RS-232 standard 8 bit data available.

Cinema Processor Interface

Format Control inputs and outputs connect via specific cables to the Dolby CP65, CP200 or CP55, sensing the currently selected format and providing automatic switching as required.

Front Panel Indicators

Signal Present

One LED per channel indicates that a signal level above -40 dB is present at the analog output of the DA20.

SR•D Digital

Indicates that valid digital data is being processed.

SR•D Analog

Indicates that the system has selected Dolby Stereo SR (analog) operation.

Motor 1/ Motor 2

Indicates "motor running" signals used for changeover.

Projector Changeover

Indicates the status of the changeover control lines.

Power Supply

+15 V, -15 V and +5 V.

Data Status

Numeric LED display indicates data recovery efficiency from digital print.

Signal Level

Four-LED display indicates digital audio signal level for each channel.

DA20 Internal Controls

System Delay

Three rotary switches set time delay to achieve synchronization of sound with picture through different mounting positions for digital soundhead. Adjustable from 4 to 132 frames (16 to 528 perforations) in 1/4-frame increments.

Surround Delay

Single rotary switch sets delay for left and right surround channels. 0-140 ms adjustable in 10 ms increments.

Cinema Processor Type

Selects format protocol and signal switching for Dolby CP65, CP200, or CP55.

DA20 System Specifications

Output Level

300 mV for Dolby Level (20 dB below maximum modulation) to match Dolby Cinema Processors.

Frequency Response

L, C, R, LS, RS, S: 20 Hz to 20 kHz
±0.5 dB. SW: 20 Hz to 120 Hz
±0.5 dB.

Noise Level

More than 72 dB CCIR/ARM below Dolby level at DA20 outputs.

Maximum Output

20 dB above Dolby level.

Dynamic Range

92 dB.

Projector Speed Tolerance

23 - 26 frames/second, nominal.

Construction

All plug-in modules are constructed using printed circuit cards, 96-way DIN connectors. Conforms to FCC class A EMI specification.

Dimensions

3 units high, rack mounting; 129 x 283 mm (5.25 in. x 19 in.).
Maximum projection behind mounting surface 362 mm (14.25in.).

Shipping Weight

9 kg (20 lb.).

Power Requirements

85 to 265 VAC, 50 - 60 Hz.

Power Consumption

Maximum 100 Watts; typical 60 Watts.

Ambient Operating Temperature

Up to 40°C.

Cat. No. 700 Digital Soundhead

Size

152.4 mm h. x 101.6 mm d. x 254mm w. (6 in. x 4 in. x 10 in.).

Shipping Weight

10.5 kg (24 lb.).

Power Requirements

Exciter lamp requires approximately 3.5 A at 10 V, provided by integral exciter lamp power supply. 85 to 264 VAC; 50- 60 Hz.

Power Consumption

Maximum 100 Watts; typical 60 Watts.

INTRODUCTION

This manual contains essential information on the installation and alignment of the Dolby Model DA20 Digital Film Sound Processor. It is designed to operate with one of Dolby Laboratories' model CP500, CP200, CP65, CP55, or CP45 Cinema Processors to allow decoding and correct playback of the Dolby Digital optical soundtrack format.

The components of the system are:

Model DA20 SR•D Digital Film Sound Processor

The rack-mounted electronic chassis containing the necessary electronics to drive one or two Cat. 700 Digital Soundheads, and decode the scanned digital soundtrack into 5.1 channels of high quality audio.

The Cat. No. 700 Digital Soundhead

The soundhead is a film-driven mechanical film transport assembly that provides a stable film path with a light source, optics, and a CCD (Charge Coupled Device) array. These components are used to scan digital data from a Dolby Digital print.

The Cat. No. 700 is shipped with a standard 10 meter video cable and a self-contained Exciter Lamp Power Supply. One Cat. No. 700 is standard with each system; a second Cat. No. 700 may be purchased for systems requiring changeover.

DA20-to-Cinema Processor Interface Kit

These interface cables connect format control and audio signals from the DA20 to the Cinema Processor. Some Cinema Processor types require upgrading to take full advantage of all digital channels produced by the DA20.

About this manual

This manual is intended to be used by individuals who are qualified in the area of cinema sound installation and service. The basic day-to-day operation of the DA20 is covered in the DA20 Users' Manual.

This installation and alignment manual covers the procedures necessary to ensure that the theatre sound system is accurately aligned to standards that have been established by Dolby Laboratories. Following these procedures will ensure that the theatre sound system will accurately reproduce the soundtrack as director and sound mixers intended.

The DA20 Digital Film Sound Processor and Cat. No. 700 Digital Soundhead work together with Dolby Cinema Processors CP500, CP200, CP65, CP55 or CP45 to provide the best possible signal to the cinema sound system. The projector, the Dolby processor, the power amplifiers and the loudspeakers, as well as the auditorium itself, must be considered when aligning the system for optimum performance. Refer to the appropriate Cinema Processor manual for alignment instructions for the A and B chains.

The system alignment procedure is divided into two parts:

1. The mechanical alignment of the Cat. No. 700 Digital Soundhead.
2. The electronic adjustment of the DA20 electronics chassis.

CAUTION

This Installation Manual is for use by qualified personnel only. To avoid electric shock do not perform any servicing other than that contained in the User's Manual unless you are qualified to do so.

SECTION 1

EQUIPMENT REQUIRED/POWER REQUIREMENTS

- 1.1 Equipment Required
- 1.2 Power Requirements
- 1.3 Regulatory Notices

1.1 Equipment Required

The following equipment is required for installation:

- a. Triggered sweep oscilloscope and probes with 20 MHz or greater bandwidth.
- b. Voltmeter for measuring Exciter Lamp Power Supply (11 Vdc)
- c. Cat. No. 69T Dolby Tone Test film
- d. Cat. No. 1010 Sync Test film (supplied)
- e. Cat. No. 1011 Channel ID Test film (supplied)
- f. Cat. No. 1012 Dolby Level Test film
- g. 2mm Allen Wrench for Focus Adjustment (supplied)
- h. 3mm Allen Wrench for Digital Soundhead Flywheel Installation (supplied)
- i. 9/16" (15mm) Open end Wrench
- j. No. 2 Phillips Screwdriver
- k. Tools for removing existing Top Reel Arm from Projector

1.2 Power Requirements

DA20

The Dolby Model DA20 may be operated from any nominal 120Vac or 240Vac power source. Voltage selection is automatic within the DA20. The switching power supply used in the DA20 may be used with mains voltages in the range 85-265 Vac, 50-60 Hz without adjustment for input voltage.

FUSE—T 2 Amp 5mm x 20mm Time Lag

The fuse may be inspected or replaced by removing the power cord from the unit and opening the hinged cover of the power entry module. The fuse holder can then be removed.

Cat. No. 700 Digital Soundhead Exciter Lamp Power Supply

The Cat. No. 700 Digital Soundhead contains an internal exciter lamp power supply and is intended for operation at nominal 120Vac or 240 Vac input and nominal 10Vdc output. The switching power supply used in the Cat. No. 700 may be used with mains voltages in the range 85-265 Vac, 50-60 Hz without adjustment for input voltage.

FUSE—T 2 Amp 5mm x 20mm Time Lag

The fuse may be inspected or replaced by removing the power cord from the unit and opening the hinged cover of the power entry module. The fuse holder can then be removed.

1.3 Regulatory Notices

FCC

This equipment has been tested and found to comply with the limits for a Class A digital device, pursuant to part 15 of the FCC Rules. These limits are designed to provide reasonable protection against harmful interference when the equipment is operated in a commercial environment. This equipment generates, uses, and can radiate radio frequency energy and, if not installed and used in accordance with this instruction manual, may cause harmful interference to radio communications. Operation of this equipment in a residential area is likely to cause harmful interference in which case the user will be required to correct the interference at his or her own expense.

UL

Troubleshooting must be performed by trained technicians. Do not attempt to service the unit unless you are qualified to do so.

WARNING: Check that the units have been set to the correct supply voltage and that the correct fuses have been installed. To reduce the risk of fire, replace the fuses only with the same type and rating. Do not use a ground-lifting adaptor and never cut the ground pin on the three-prong power plug.

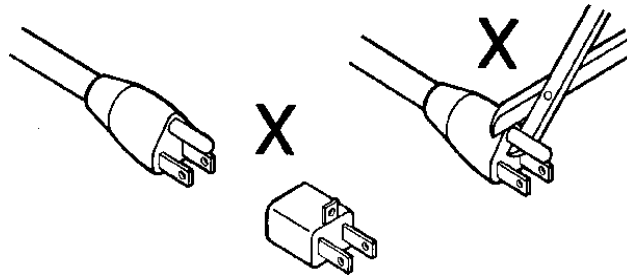

UK

Connections for United Kingdom.

WARNING: THIS APPARATUS MUST BE EARTHED.

As the colours of the cores in the mains lead may not correspond with the coloured markings identifying the terminals in your plug, proceed as follows:

- The core which is coloured green and yellow must be connected to the terminal in the plug which is marked with the letter **E** or by the earth symbol \perp , or coloured green or green and yellow.
- The core which is coloured blue must be connected to the terminal which is marked with the letter **N** or coloured black.
- The core which is coloured brown must be connected to the terminal which is marked with the letter **L** or coloured red.

Europe

This unit complies with the requirements of EN 60065, EN 55103-1 and EN 55103-2 when installed in an E2 environment in accordance with this manual.

IEC NOTICES

IMPORTANT SAFETY NOTICE

This unit complies with the safety standard IEC65. To ensure safe operation and to guard against potential shock hazard or risk of fire, the following **must** be observed:

- If the unit has a **voltage selector**, ensure that it is set to the correct mains voltage for your **supply**. If there is no voltage selector, ensure that your supply is in the correct range for the input requirement of the unit.
- Ensure **fuses** fitted are the **correct rating and type** as marked on the unit.
- The unit **must be earthed** by connecting to a correctly wired and **earthed** power outlet.
- The **power cord** supplied with this unit must be wired as follows:
Live—Brown Neutral—Blue Earth—Green/Yellow

GB

IMPORTANT – NOTE DE SECURITE

Ce matériel est conforme à la norme IEC65. Pour vous assurer d'un fonctionnement sans danger et de prévenir tout choc électrique ou tout risque d'incendie, veuillez à observer les recommandations suivantes.

- Le selecteur de tension doit être placé sur la valeur correspondante à votre alimentation réseau.
- Les fusibles doivent correspondre à la valeur indiquée sur le matériel.
- Le matériel doit être correctement relié à la terre.
- Le cordon secteur livré avec le matériel doit être câblé de la manière suivante:
Phase—Brun Neutre—Bleu Terre—Vert/Jaune

F

WICHTIGER SICHERHEITSHINWEIS

Dieses Gerät entspricht der Sicherheitsnorm IEC65. Für das sichere Funktionieren des Gerätes und zur Unfallverhütung (elektrischer Schlag, Feuer) sind die folgenden Regeln unbedingt einzuhalten:

- Der Spannungswähler muß auf Ihre Netzspannung eingestellt sein.
- Die Sicherungen müssen in Type und Stromwert mit den Angaben auf dem Gerät übereinstimmen.
- Die Erdung des Gerätes muß über eine geerdete Steckdose gewährleistet sein.
- Das mitgelieferte Netzkabel muß wie folgt verdrahtet werden:
Phase—braun Nulleiter—blau Erde—grün/gelb

D

NORME DI SICUREZZA – IMPORTANTE

Questa apparecchiatura è stata costruita in accordo alle norme di sicurezza IEC 65. Per una perfetta sicurezza ed al fine di evitare eventuali rischi di scossa elettrica o d'incendio vanno osservate le seguenti misure di sicurezza:

- Assicurarsi che il selettore di cambio tensione sia posizionato sul valore corretto.
- Assicurarsi che la portata ed il tipo di fusibili siano quelli prescritti dalla casa costruttrice.
- L'apparecchiatura deve avere un collegamento di messa a terra ben eseguito; anche la connessione rete deve avere un collegamento a terra.
- Il cavo di alimentazione a corredo dell'apparecchiatura deve essere collegato come segue:
Filo tensione—Marrone Neutro—Blu Massa—Verde/Giallo

I

AVISO IMPORTANTE DE SEGURIDAD

Esta unidad cumple con la norma de seguridad IEC65. Para asegurarse un funcionamiento seguro y prevenir cualquier posible peligro de descarga o riesgo de incendio, se han de observar las siguientes precauciones:

- Asegúrese que el selector de tensión esté ajustado a la tensión correcta para su alimentación.
- Asegúrese que los fusibles colocados son del tipo y valor correctos, tal como se marca en la unidad.
- La unidad debe ser puesta a tierra, conectándola a un conector de red correctamente cableado y puesto a tierra.
- El cable de red suministrado con esta unidad, debe ser cableado como sigue:
Vivo—Marrón Neutro—Azul Tierra—Verde/Amarillo

D

VIKTIGA SÄKERHETSÅTGÄRDER!

Denna enhet uppfyller säkerhetsstandard IEC65. För att garantera säkerheten och gardera mot eventuell elchock eller brandrisk, måste följande observeras:

- Kontrollera att spänningsväljaren är inställd på korrekt nätspänning.
- Kontrollera att säkringarna är av rätt typ och för rätt strömstyrka så som anvisningarna på enheten föreskriver.
- Enheten måste vara jordad genom anslutning till ett korrekt kopplat och jordat el-uttag.
- El-sladden som medföljer denna enhet måste kopplas enligt följande:
Fas—Brun Neutral—Blå Jord—Grön/Gul

S

BELANGRIJK VEILIGHEIDS-VOORSCHRIFT:

Deze unit voldoet aan de IEC65 veiligheids-standaards. Voor een veilig gebruik en om het gevaar van elektrische schokken en het risico van brand te vermijden, dienen de volgende regels in acht te worden genomen:

- Controleer of de spanningscarroussel op het juiste Voltage staat.
- Gebruik alleen zekeringen van de aangegeven typen en waarden.
- Aansluiting van de unit alleen aan een geaarde wandcontactdoos.
- De netkabel die met de unit wordt geleverd, moet als volgt worden aangesloten:
Fase—Bruin Nul—Blauw Aarde—Groen/Geel

NL

SECTION 2

INITIAL SETUP AND INSTALLATION

- 2.1 Mounting the Digital Soundhead
- 2.2 Electrical Connections to the Soundhead
- 2.3 Connection to Motor Start Relays
- 2.4 Connections to Dolby Cinema Processors

2.1 Mounting the Digital Soundhead

Adapter Plates

The Cat. No.700 Digital Soundhead casting has bolt patterns for several common projector types, and may be mounted to these projectors without an adapter plate:

SIMPLEX 35/70 and XL35
 CENTURY JJ with 2" bolt adapter
 CENTURY 35MM-A
 CHRISTIE P35
 BALLANTYNE PR0 35

Adapter kits are available for the following projector types.

CINEMECCANICA	V8 / V5 Order Cat. No.690 Adapter Kit (plate Part No. 67185) needed for re-installing the reel arm to the top of the digital reader.
NORELCO	AAII / DP70 Order Cat. No.695 Adapter Kit (plate Part No. 67079)
KINOTON	DP75, FP20, FP30 Order Cat. No.696 Adapter Kit (plate Part No. 67139)

Additional plates may become available. Consult Dolby Laboratories for availability.

Mounting the soundhead on a projector is accomplished by selecting the appropriate adapter plates (if needed), attaching the plates to the soundhead casting, then bolting the plate to the projector and the reel arm or platter guide roller assembly. Lateral positioning is verified by threading a piece of film through the Digital Soundhead and the projector, and verifying equal tension on each edge.

Installation

While the Digital Soundhead is rugged and reliable, it has been designed and built to precision optical and mechanical tolerances. Handle the unit very carefully.

1. Remove the package of parts from the top of the shipping box.
2. Pull out the inner box containing the Digital Soundhead, and slide it out of the surrounding foam. Place the digital soundhead on a table or bench top, with

mounting base down. The mounting base is the surface with thirteen mounting holes. **Figure 2.1** shows how the mounting holes correspond to bolt patterns for various projectors. This diagram shows the hole pattern as viewed from the top, inside the housing.

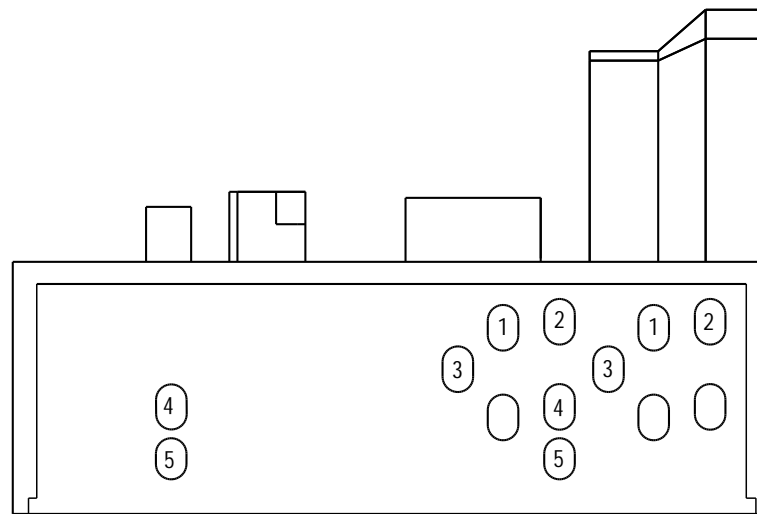

VIEW FROM INSIDE OF READER LOOKING DOWN

- | | |
|---|--|
| 1 | CENTURY JJ WITH 50.8 MM (2 INCH) BOLT PATTERN REEL ARM ADAPTER
SIMPLEX 35 |
| 2 | CHRISTIE
CENTURY 35 |
| 3 | SIMPLEX 35 - 70 |
| 4 | CINEMECCANICA V4, V5, V8 (35 mm), V9 |
| 5 | CINEMECCANICA V8 (70 mm) |

Figure 2.1 Mounting Hole Bolt Pattern

3. Remove the six screws which hold the back cover / power supply assembly onto the Digital Soundhead. Carefully remove the exciter lamp from its holder. Put the assembly in a safe place.
4. Remove the upper reel arm or guide rollers from the projector on which the Digital Soundhead is to be mounted.
5. If an adapter kit is necessary, mount the adapter plate to the top of the projector. In the case of the Cat. No.690 adapter kit, the reader attaches to the projector and the adapter plate attaches to the top of the reader.
6. Mount the Digital Soundhead to the projector body (or adapter plate) matching the appropriate set of bolt holes for the projector type.

NOTE: When two Cat. No.700 Digital Soundheads are mounted for use in a two-projector installation, care must be taken to ensure that the film path lengths between the Digital Soundhead and the picture gates in the two projectors are identical. The soundhead delay setting in the DA20 is adjusted for correct synchronization of sound and picture during installation. Since only one adjustment is provided, both projectors must have the same film path length from the Digital Soundhead to the picture gate.

7. Reattach the upper reel arm or guide rollers to the Digital Soundhead, using an adapter plate if necessary.

8. Thread film through the Digital Soundhead and first few rollers of the projector and adjust the placement of the Digital Soundhead such that there is equal tension on each edge of the film, then firmly tighten the mounting bolts.

Set film path so that top and bottom tension arm rollers (A) are approximately 5 MM (1/4 inch) apart. Use the white painted semi-circles (B) for angular alignment of tension arms (C). Make sure that the rollers do not touch.

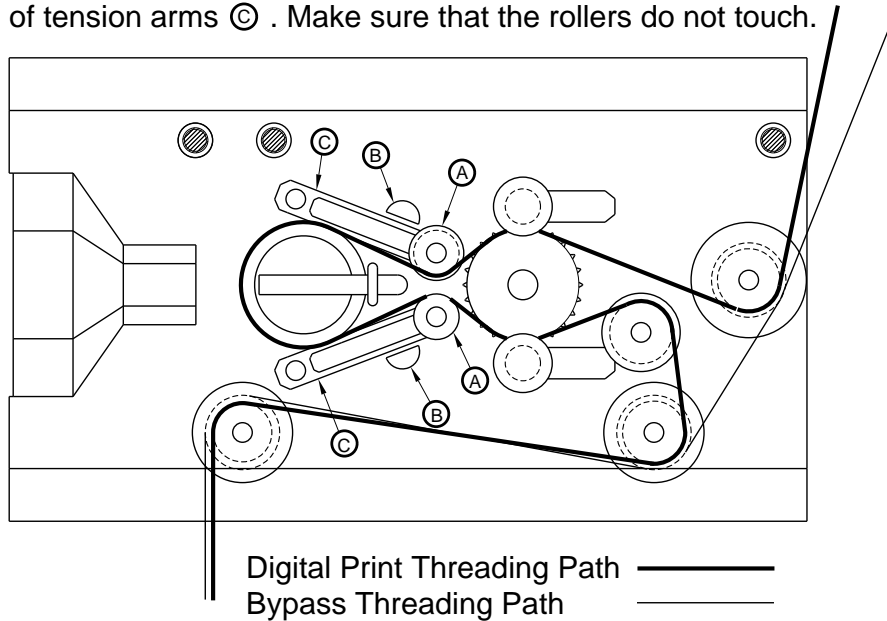

9. Route appropriate conduit from the audio rack where the DA20 is to be installed to the Cat. No.700 Digital Soundhead, terminating the conduit at the end of the Digital Soundhead. The soundhead has an unthreaded 27 mm diameter hole in a 2 mm plate to accept 3/4" (USA) conduit fittings or 25 mm (Europe) conduit adapters. Be sure to follow all local electrical codes.
10. Remove the shipping collar using the supplied Allen wrench, and install the Digital Soundhead flywheel, which is packed separately for shipping (see **Figure 2.2**).
11. Replace the cover / power supply assembly.
12. Connect mains power to the Cat. No. 700 Digital Soundhead. Route the video cable to the soundhead (see Section 2.2).

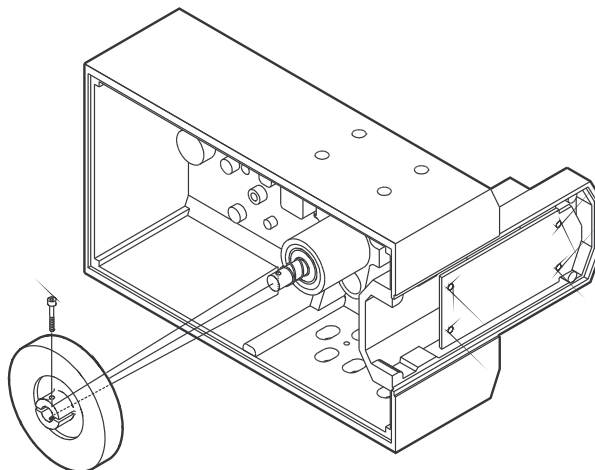

Figure 2.2 Flywheel Mounting

2.2 Electrical Connections to the Digital Soundhead

Video Cable Mounting Assembly

The video cable is normally mounted to the Cat. No. 700 by a cable clamp, a locknut and two washers. Figure 2.3 shows the details of this mounting assembly. This method is used in non-conduit installations.

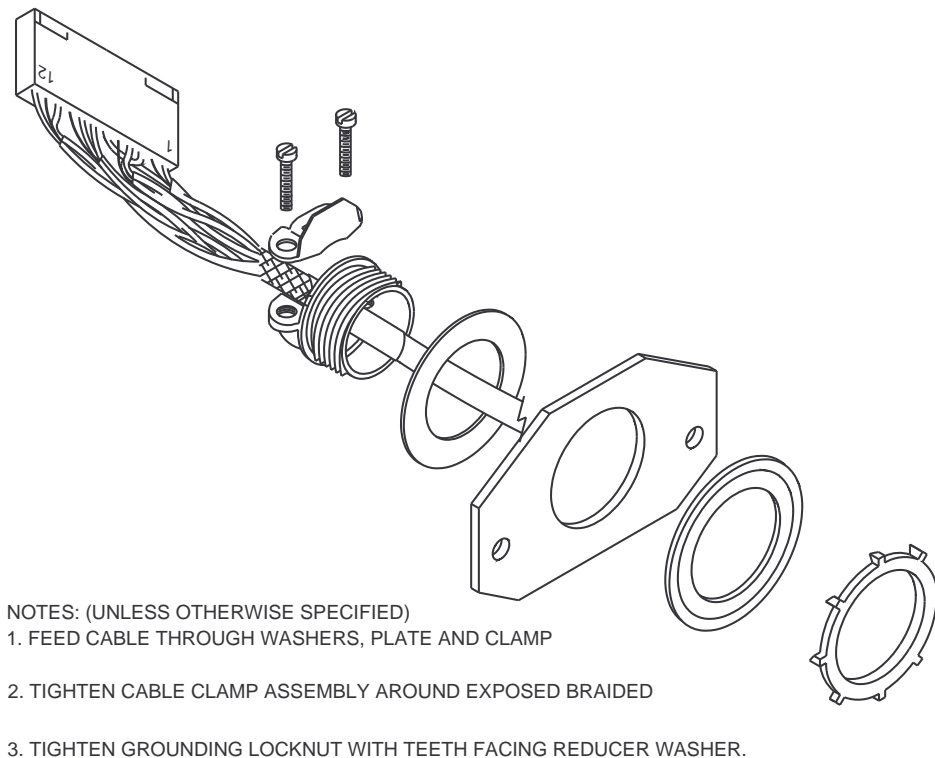

Figure 2.3 Assembly Video Cable Clamp

If the cable is installed in conduit, then the cable clamp assembly should be removed from the Cat. No.700 mounting plate and replaced with the appropriate hardware for the conduit installation.

Exciter Lamp Power

The Cat. No.700 Digital Soundhead comes equipped with a 10V power supply to power the internal tungsten-halogen exciter lamp. This supply is powered via an IEC mains connector on the rear of the soundhead. A 2 meter long power cord is included. Outside the United States the appropriate connector (not supplied) must be attached to the power cord. See Section 1.3 for the required mains connector wiring. The supply will operate on 85-265 Vac, 50-60 Hz.

Video Cable

The video cable connects the Cat. No.634 CCD Board in the Digital Soundhead to the DA20. This cable should be pulled through grounded metal conduit or other shielded wireway to meet EMI emission standards. The male DB25 connector is attached to the DA20 end of the cable; on the other end a 12-way Molex connector is attached. The standard cable is 10m (about 30 feet) long. 30m (about 100 feet) or 15m (about 50 feet)

cables are available. An extra set of connector pins is included in case it is necessary to cut the cable for any reason.

Plug the Molex connector onto the CCD board in the Digital Soundhead before plugging the male DB25connector onto the DA20.

Three ferrite blocks are shipped with the Cat. No.700. One of these should be installed near each end of the video cable. If the cable is installed in conduit then place the blocks at the DA20 end. If the cable is not in conduit then installation of these ferrite blocks is essential to prevent excessive RF energy radiation, and should be placed near each end of the cable.

Plug the Molex connector onto the CCD board in the Digital Soundhead before plugging the male DB25connector onto the DA20.

2.3 Making a Custom Video Cable

The following information is included for use when a cable is being made up on site. The cable should be Belden Datalene 8164, which contains four shielded twisted pairs of computer-grade cable with the shields isolated from each other plus a 100% coverage overall shield. Using other types of cable may result in unsatisfactory operation. The overall shield is necessary to prevent RF interference signals from radiating from the video cable, causing possible complaints and violating government EMI standards. A metal shell **MUST** be used on the D-connector and the overall shield **MUST** be grounded to the connector shell to ensure proper operation and compliance with EMI regulations.

Wiring table for DB25 end of video cable

25 pin D-connector pin no.	Molex pin no.	Wire Color	Signal name
1			n.c.
2			n.c.
3			n.c.
4	7	Blue	TTC
5	9	Shield	TC GND
6	8	Black	FTC
7	10	White	TSC
8	11	Shield	SC GND
9	12	Black	FSC
10			n.c.
11			n.c.
12			n.c.
13			n.c.
14	1	Black	Video 0
15	2	Shield	GND
16	6	Red	+15V
17	3	Black	Video 1
18	5	Shield	GND
19	4	Green	-15V
20 through 25			n.c.

Wiring to the Molex Connector

1. Strip back vinyl outer jacket of cable to 3.0 inches.

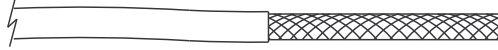

2. Add 1/2 inch dia heat-shrink about 1/4 inch long near end of vinyl outer jacket.

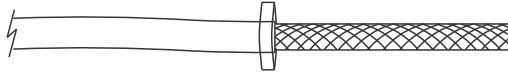

3. Fold outer shield braid back over vinyl outer jacket.

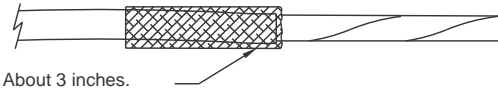

4. Trim back outer foil shield and plastic cords.

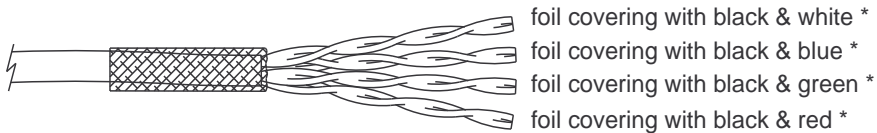

foil covering with black & white *
 foil covering with black & blue *
 foil covering with black & green *
 foil covering with black & red *

* foil color may vary depending upon cable manufacturer

5. Install shrink tubing.

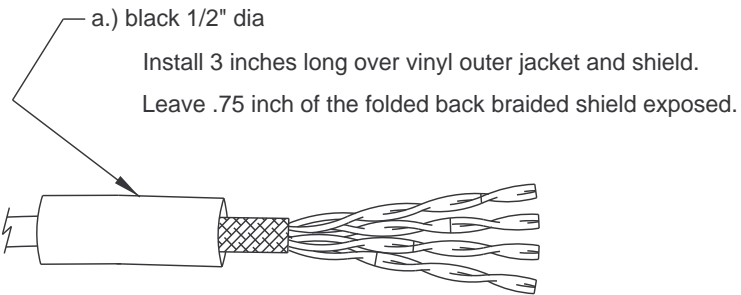

- b.) clear 1/8" dia
 2.4 inches on foil covering with black & white *
 2 inches on foil covering with black & blue *
 1.5 inches on foil covering with black & green *
 1.2 inches on foil covering with black & red *

6. Strip back foil to edge of 1/8 inch shrink tubing.

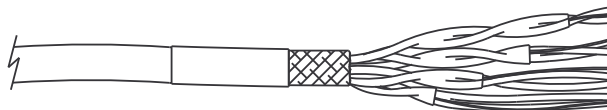

7. Cut exposed wiring and twisted shield to the lengths indicated below; measured from end of the outer cable casing.

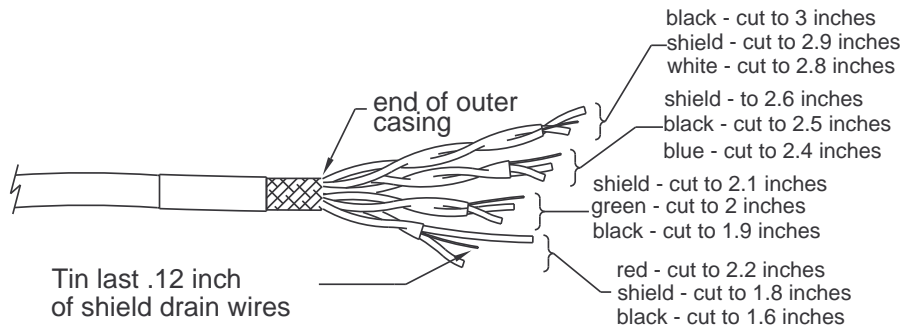

8. Strip insulated wires back .12 inch and tin

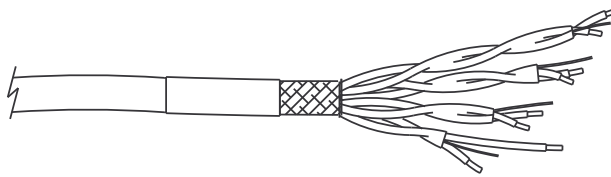

9. Install 1/16 inch dia clear shrink tubing over each drain wire of the twisted pairs and heat shrink.

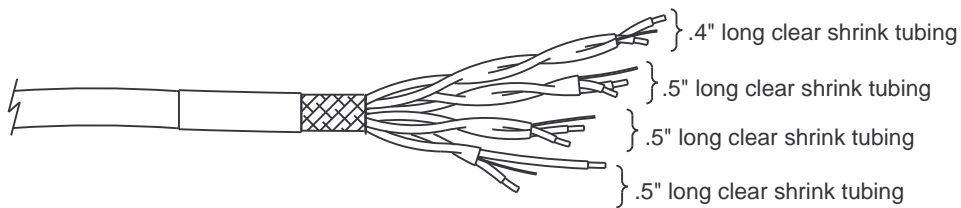

10. Crimp Molex pins onto wires, 12-PL, using Molex tool HTR-2262-20A, then solder pins to wires.

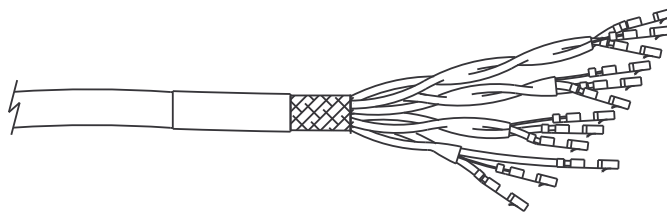

11. Arrange wires in the following order and bend them 90 degrees as shown.

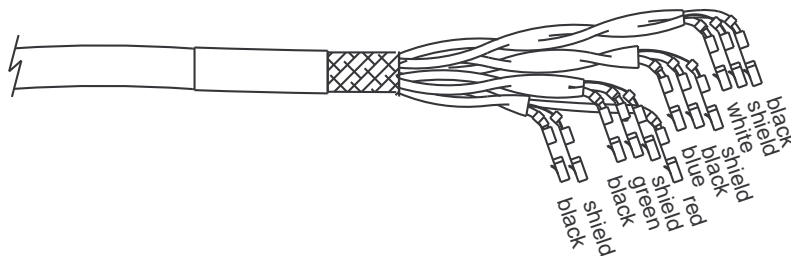

12. Install pins into Molex housing according to wiring table

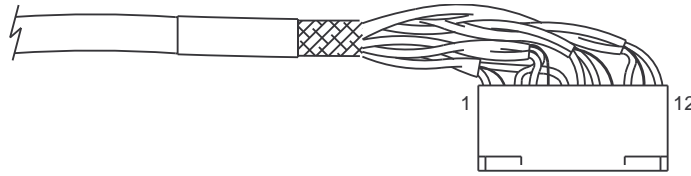

The pins must be inserted in the Molex connector block as shown in the following table.



Perform this operation before plugging the male DB25 connector into the DA20. Incorrect placement of pins will result in damage to the Cat. No.634 CCD board or the Cat. No. 670 video acquisition module.

Plug the Molex connector onto the CCD board in the Digital Soundhead before plugging the male DB25 connector onto the DA20.

Pin 1 is to the left when the Molex connector is connected to the Cat. No.634 CCD Board in the Cat.No.700 Digital Soundhead. This assembly is easiest if you insert the shortest leads first.

Wiring table for inserting pins in red Molex connector block

Molex pin no.	Wire color	Signal name
1	Black	Video 0
2	Shield	GND
6	Red	+15V
3	Black	Video 1
4	Green	-15V
5	Shield	GND
7	Blue	TTC
8	Black	FTC
9	Shield	TC GND
10	White	TSC
11	Shield	SC GND
12	Black	FSC

The cable clamp which is attached to the Cat. No.700 cable mounting plate, along with the exposed braid on the video cable, provide an electrical ground path for the shield of the video cable.

This video cable shield may be isolated if necessary by loosening the 2 screws which clamp the video cable shield and installing an insulator around the braided shield (such as 1/2 inch diameter heat shrink tubing). It is important to re-tighten the cable clamp after installing the insulation to provide strain relief for the video cable.

2.4 Connection to Motor Start Relays—For 2 Projector Installations

Because the data on the Dolby Digital track is normally read in advance of the picture gate, in a two projector changeover system the DA20 requires signals in advance of a changeover. Motor Start contact closures provide these signals (see DA20 to CP wiring diagrams, **Figures 2.9, 2.10, 2.11, 2.18, 2.19**).

In a single projector system, the DA20 requires the MS1 signal to be valid when the projector motor is running in order to allow switching to the analog soundtrack when digital data is not present. **If the MS1 signal is not connected to Digital Ground, the DA20 will not switch to analog if the digital signal is unreadable.** Installation of a relay is preferred, but installing a wire link from J9 pin 1 to J9 pin 5 will cause the DA20 to assume that the motor is running constantly, allowing automatic switching to analog if required. The drawback of a wire link is that the system will be in analog rather than muted digital during projector startup. The DA20 is shipped with this link installed.

Signal Levels

Normally pulled to +5V through 10k ohms.

Low: less than 1.0 Vdc with respect to signal ground.

High: greater than 3.5 Vdc, less than 18 Vdc with respect to signal ground.

Isolated contact closures from mechanical or opto-isolated relays wired across projector motors must be used.

Projector Motor Start Input Connector J9 (DB9 Female) Pinout

DA20 Motor Start Conn. J9 (DB9 Female) Pin no.	External Relays
1 MS1	Close to pin 5 when Proj. 1 running
2	
3	
4	
5 DGND	Common Contact
6	
7	
8	
9 MS2	Close to pin 5 when Proj. 2 running

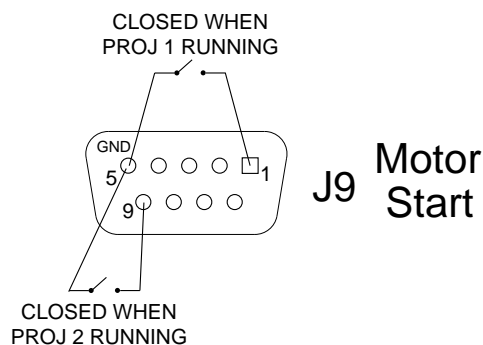

Figure 2.4 Motor Start Connector

2.5 Connections to Dolby Cinema Processors

The DA20 may be connected to any of five Dolby Cinema Processors: the CP45, CP55, CP65, CP200, or CP500. Two types of electrical connections must be made between the DA20 and the cinema processor:

1. Audio through DA20 rear panel connectors J7 and J8.
2. Cinema processor format sensing and control through DA20 rear panel connector J6.

The specifics of connection to these connectors are described for each Cinema Processor type.

2.5.1 Installation of DA20 with CP55

Refer to the CP55 wiring diagram fold-out (**Figure 2.9**).

To playback Dolby SR and Dolby Digital films correctly it is highly recommended that you upgrade the CP55 for Dolby SR. The Dolby Model SRA5 adapter is no longer available, however you should arrange to acquire a Cat. No. 222SR/A card. This card replaces the existing Cat. No. 222 noise reduction card and provides two channels of Dolby SR processing and Dolby A-type noise-reduction.

2.5.1.1 Revised SRA5 installation procedure (If your theatre is so equipped)

The following section is for an existing installation with Model SRA5 available. If you do not have an SRA5 installed, skip this section and go to Cat. No.441 Installation, Section 2.5.1.2.

The original SRA5 installation procedure was developed in order to avoid soldering to the backplane of the CP55. Unfortunately, this method makes use of the AUX format, which will be needed for use by the DA20. Therefore, if your theater is equipped with an SRA5 installed in the original way, you will need to revise the installation before proceeding further. (If you are reconnecting an SRA5 that was previously connected using the original method, make sure to remove the wire connecting the OBE terminal on TB2 of the SRA5 to J18 on the CP55. Unplug the D-Sub connector from CP55 J18, cut the wire at the SRA5 end and discard this wire.)

This procedure describes an alternative method of interfacing the Dolby SRA5 to a CP55 cinema processor. An advantage of this method is that the SRA5 signal output is returned to the CP55 via the Dolby tone inputs of the Cat.No.222 card instead of using the non-sync inputs as in the standard method. As a result, the non-sync source can remain connected to the CP55 non-sync terminals. Using the Dolby tone input also provides a fixed input level, so no signal calibration needs to be performed.

This method relocates the Dolby Stereo SR format to "03," making the "AUX" signal input and selector button available for use in selecting the Dolby Digital format.

The only drawback to this method is that the Dolby tone inputs are only accessible by soldering directly to the Cat.No.222 edge connector. This is a simple procedure, but one that must be done carefully to avoid splashes that can cause short circuits.

Installation

The changes below move **format 05** (Dolby Stereo SR) to the **format 03** button, freeing up the **aux** button for the Dolby Digital input.

1. Set the SRA5 CP selector switch to the "55" position.
2. Set the SRA5 Mode switch located behind the front access panel to "Remote."
3. Use a shielded pair such as Belden #8451 for the audio and an 18-24 gauge single conductor wire for the control line. Connect the shields at the SRA5 end only. Perform the following wiring steps (refer to **Figure 2.5**):

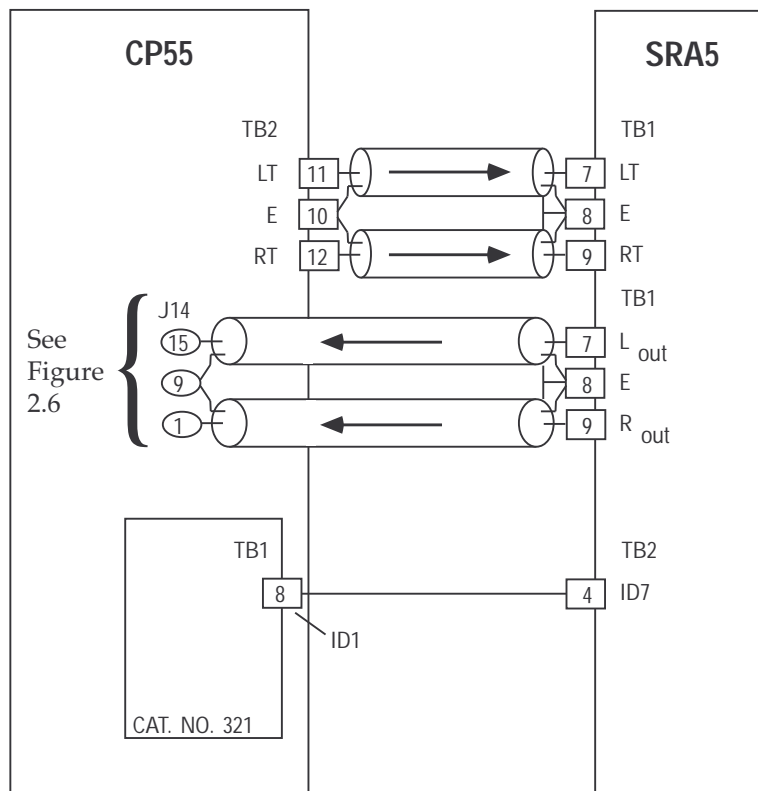

Figure 2.5 SRA5 to CP55 Connections (Alternative Method)

- a. Connect the Lt and Rt inputs on the SRA5 to the Optical Preamp Outputs on TB2 of the CP55.
- b. Connect the ID7 terminal on the SRA5 to the ID1 terminal on TB1 of the Cat.No.321 on the back of the CP55.
- c. Connect the Lout and Rout outputs from the SRA5 to the pins of edge connector **J14** on the backplane of the CP55, (see **Figure 2.6**) by carefully soldering the wire for the Left channel to pin 15 and Right channel to pin 1. Solder the ground to pin 9.

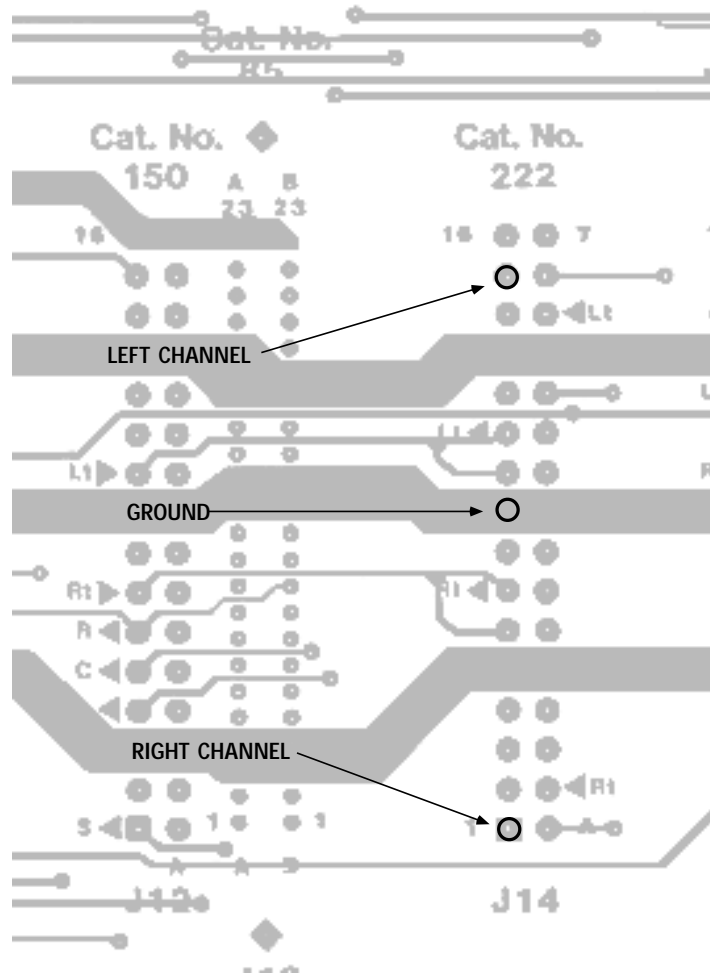

Figure No. 2.6 Backplane connections at J14

4. Since the function of the front panel 03 button is now changed to format 05 and the aux button now selects Dolby Digital, an adhesive label is included to re-label the front panel.

Clean the area of the front door around the format selection buttons with alcohol to remove any greasy film that may be present and would interfere with good adhesion of the label to the door. Remove the label backing material and carefully position the sticker and press it onto the panel. Press it firmly over the entire area to ensure good adhesion.

5. Remove the Cat.No.243 from the CP55 and modify the programming of the control matrix.
 - a. Locate the line of diodes labeled "F1." First remove diodes D29 and D33 from the card.
 - b. Add two diodes as shown in **Figure 2.7**. The holes for the anode end of the new diodes may be filled with solder. Use a solder removing tool to clear these holes before installing the new diodes. Make sure the polarity is as shown below on the added diodes.

- c. If an SRA5 is currently installed using the AUX format, remove diodes D61, D64, D65, D66, and D72 shown in Figure 2.7 with an **X**. Add diode D67 shown with a **✓**.
- d. Reinstall the Cat.No.243 in the CP55.

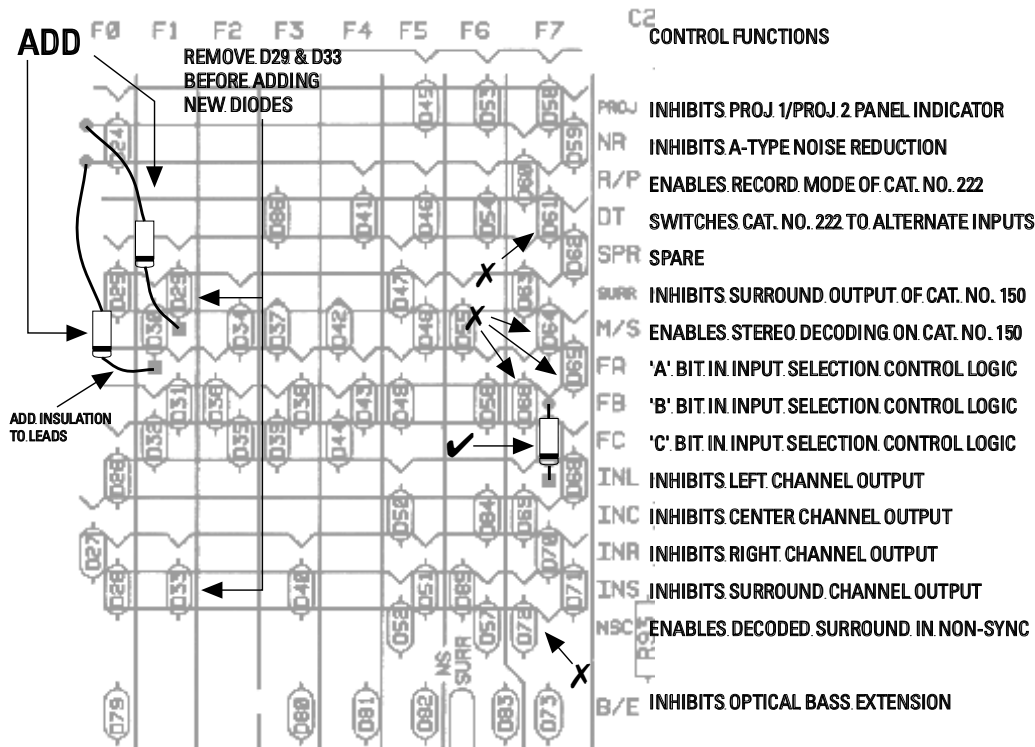

Figure 2.7 Cat. No.243 Diode Modifications

6. Check for proper operation by performing the following tests:
 - a. Select a non-Dolby format ("01" for example). The "SR OUT" LED on the SRA5 front panel should be on.
 - b. Select the "05 Dolby Stereo SR" format button. The "SR IN" LED on the SRA5 should be on.
7. Run a pink noise film loop (Cat.No.69) and observe the frequency response in the auditorium when switching between formats 04 (A-Type) and 05 (SR). Observe that the pink noise sounds slightly louder and brighter when Dolby SR format 05 is selected. The LEDs on the SRA5 front panel should indicate "SR IN" for the "05" format and "SR OUT" for any other format.

2.5.1.2 Cat. No. 441 installation

The Cat. No.441 card provides the necessary right surround and subwoofer channels along with Surround EQ. The Cat. No.441 will work in a CP55 even if the CP55 is not modified, but will only do what a Cat. No.241 will do. To enable its full functioning as required for Dolby Digital installations, modification of the CP55 backplane is required.

Ensure that you have good access to the backplane (rear) side of the CP55 and have adequate light. Add leads between pins as described below. See Figure 2.8:

Cat. No. 242 Pin 19 to Cat. No. 441 Pin 10
 Cat. No. 242 Pin 17 to Cat. No. 441 Pin 11
 Cat. No. 242 Pin 16 to Cat. No. 441 Pin 12
 Cat. No. 242 Pin 9 to Cat. No. 441 Pin 3
 Cat. No. 441 Pin T to S
 Cat. No. 441 Pin K (gnd) to S
 Cat. No. 441 Pin 7 to TB3 Pin 1 (Rs Out)
 Referring to the fold-out on page 2-17:
 DA20 cable light blue wire to Cat. No. 441 Pin M (Rs Input)
 DA20 cable white wire to Cat. No. 441 Pin R (digital SW Input)

In addition, ground TB3 pin 2 to the circuit ground at TB3 pin 4. This arrangement provides muting of the Rs output when in bypass and is necessary to prevent loud thumps when power to the CP55 is turned on.

The Rs output is now conveniently available at TB3 pin 1. **NOTE: the output labeled "S" on the CP55 is now the Ls output.** When any format but Dolby Digital is selected, the mono surround signal feeds both surround outputs.

The two inputs from the DA20 (Rs and SW) will have to be soldered directly to the indicated backplane pins of the Cat. No.441. As the cable plugs in to the DA20 end of things, it will still be possible to disconnect the units from each other without soldering.

The subwoofer output on the CP55 is called B/E (bass extension) and is found at TB3 pin 12. It will now automatically select either the optical input or the Dolby Digital input according to the format selected by the front panel switches or remote control inputs.

In order to get the correct input level from the Cat. No.85C pink noise generator, two more modifications are needed. First, cut the trace that leads from the Cat. No.441 socket pin D toward your right. Solder a wire from the side of the cut trace away from the Cat. No.441 to Cat. No.441 pin A. Next, connect a 105K resistor (furnished) between Cat. No.441 connector pins A to D.

Warning: The subwoofer pink noise level in a CP55 so modified but with a Cat. No.241 plugged in will now be 20 dB too low, although the Cat. No.241 will otherwise do just what it used to do.

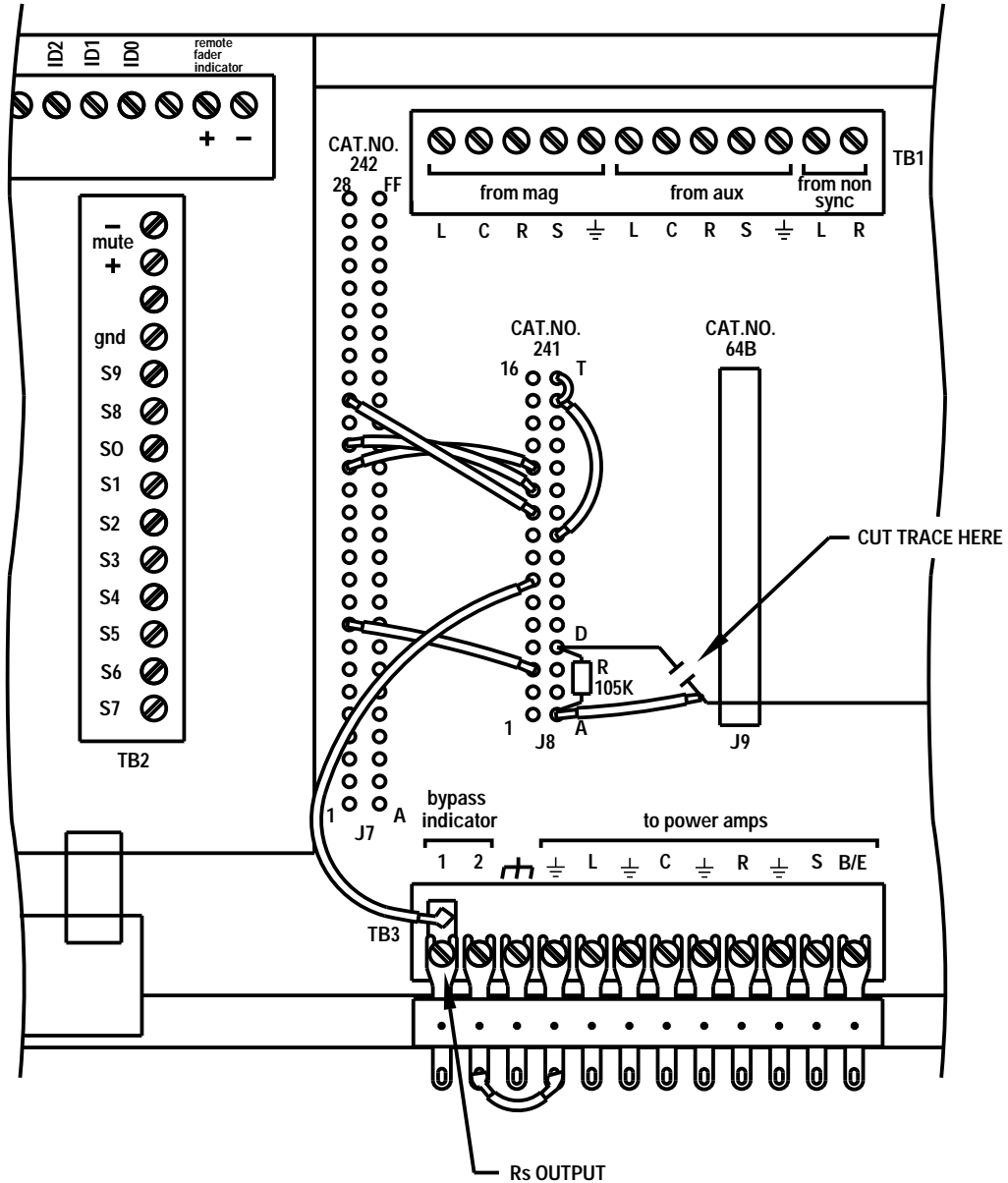

Figure 2.8 CP55 Backplane Modifications for Cat. No.441

2.5.1.3 Cat. No. 441 Control Functions Label

The controls on the Cat. No.441 are different from those of the Cat. No.241. To assist in alignment and prevent confusion, we have included a label that replaces the control identification drawing on the inside of the front panel. Clean the area of the inside of the door where the CP65 modules and controls are described. Remove the label backing material and carefully position the sticker and press it onto the panel. Press it firmly over the entire area to ensure good adhesion.

Connections Listing—CP55 to DA20 (See fold-out Figure 2.9)

Audio from DA20 to CP55

DA20 CP Audio out Conn. J8 (DB25 Male) Pin no.	CP55 TB1
1 AGND	GND
2 Rs out	CP55 backplane Cat. No. 241 pin M
3 AGND	
4 AGND	
5 AGND	
6 AGND	
7 AGND	
8 AGND	
9 AGND	
10 AGND	
11 AGND	
12 AGND	
13 AGND	
14 L out	L from Aux
15 Ls out	S from Aux
16 Re out	
17 R out	R from Aux
18 Le out	
19 n.c.	
20 C out	C from Aux
21 S out	
22 n.c.	
23 n.c.	
24 SW out	CP55 Cat. No. 241 Pin R
25 Spare out	

CP55 to DA20 Sense/Control

DA20 J6 DB25 Male Pinout	CP55 Cat. No. 321 TB2 Fanning Strip
1 Ctrl0	S0 (01 - mono optical)
2 Ctrl1	S1 (05 - Dolby SR)
3 Ctrl2	S2 (04 - Dolby Stereo)
4 Ctrl3	S3
5 Ctrl4	S4 (22 - mag)
6 Ctrl5	S5
7 Ctrl6	S6 (60 - non-sync.)
8 Ctrl7	S7 (10 - Dolby Digital)
9 n.c.	
10 n.c.	
11 n.c.	
12 GND	GND
13 n.c.	
14 Sense0	
15 n.c.	
16 n.c.	
17 n.c.	
18 n.c.	
19 n.c.	
20 n.c.	
21 n.c.	
22 n.c.	
23 n.c.	
24 n.c.	
25 C/O Status	(CP55 backplane TB2) Auto C/O

Format sense and control is accomplished via connection of CP S0 through S7 lines, connected to DA20 CTRL0 through CTRL7. The DA20 monitors CTRL lines and asserts formats depending on the mode of operation of the DA20. Valid format assertions are detected when any one CTRL line is low for greater than 80ms. See the DA20 Users' Manual for specific information related to the DA20 modes of operation and the Auto Digital feature.

The DA20 switches to format 05 by holding CTRL1 low for approximately 150ms and returns to format 10 by holding CTRL 7 low for approximately 150ms. (The CP55 requires about 50ms to switch formats.)

2.4.1.4 Cat. No. 441 Alignment

The Cat. No. 441 alignment procedure (taken from the CP65 Installation Manual) begins here.

Subwoofer Alignment

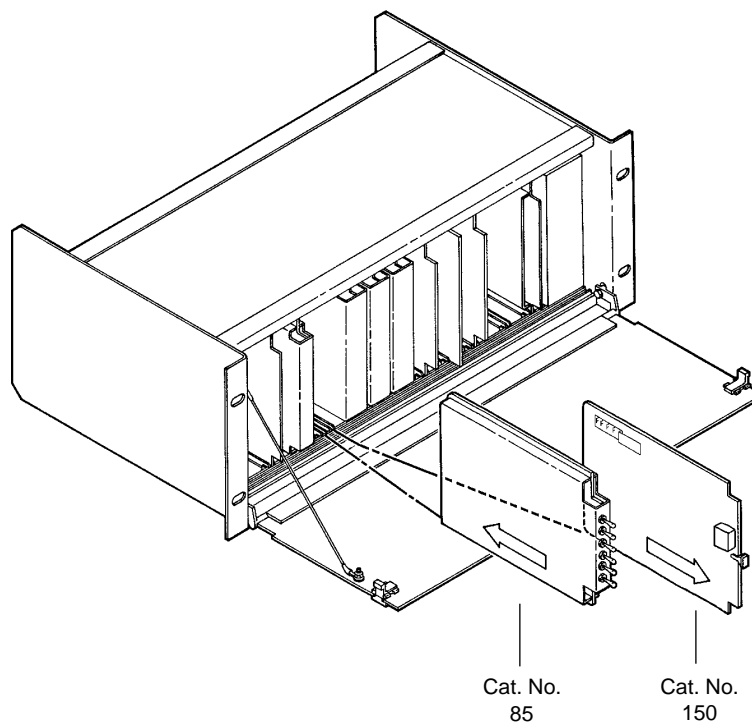

Remove the Cat. No. 150 Card. Note that when the Cat. No. 150 card is removed, two card edge connectors are exposed on the backplane and that another slot to the immediate left of the Cat. No. 150 slot is accessible. This second slot and associated connector are for the Cat. No. 85C Pink Noise Generator.

Install the Cat. No. 85C Pink Noise Generator in the special slot to the left of the Cat. No. 150 slot. The switches in the Cat. No. 85C are up or down for **ON** and center for **OFF**. The phase is positive when the switches are in the up position and negative in the down position.

Cat. No. 441 Alignment Instructions from the CP65 Manual

Cat. No. 441—Subwoofer Alignment

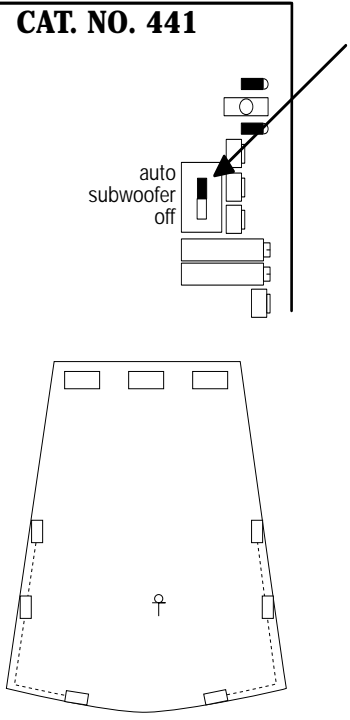
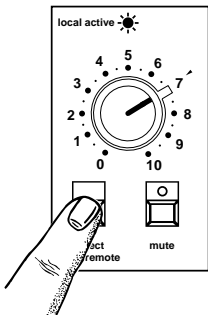
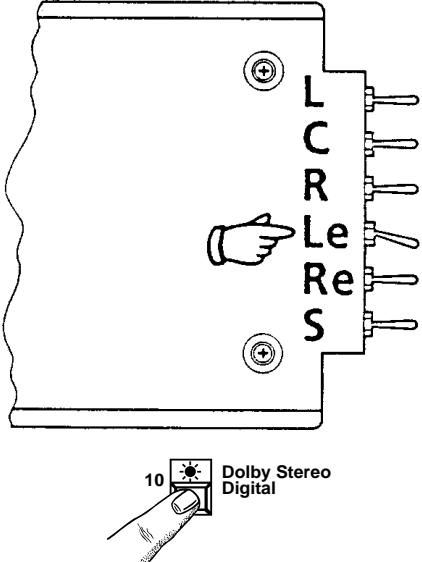
Step No.	Action	Indication
<p>1</p>	<p>CAT. NO. 441</p> 	
<p>2</p>		
<p>3</p>		

Notes

The **Subwoofer auto/off** switch on the Cat. No. 441 card enables the subwoofer in formats other than Non-sync (format 60) , Mono (format 01) and magnetic no NR (format 22). The switch must be in the **auto (up)** position at any time the subwoofer system is to function.

Confirm that the microphone is in the position shown.

All connections established in the room equalization procedure apply to the following steps.

The main front panel **FADER** should be active and set to **7**. If necessary, press the **select local/remote** switch.

Place the Le toggle switch on the Cat. No. 85C card in the ON (up or down) position and set the CP65 to format **10 Dolby Digital**.

Cat. No. 441 Alignment Instructions from the CP65 Manual

Cat. No. 441—Subwoofer Alignment

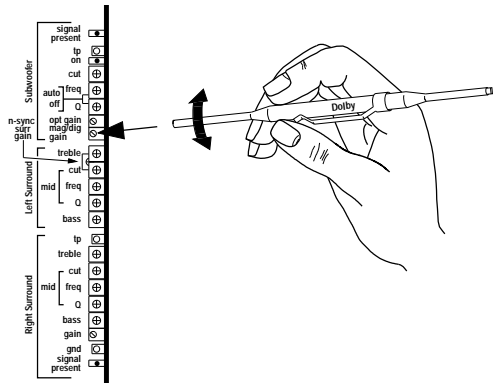
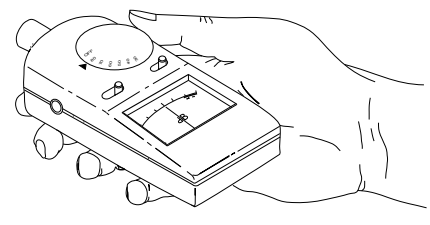
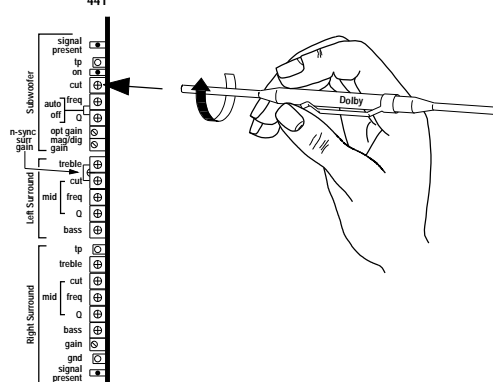
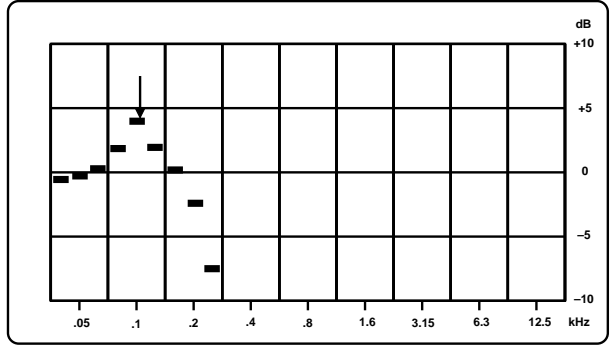
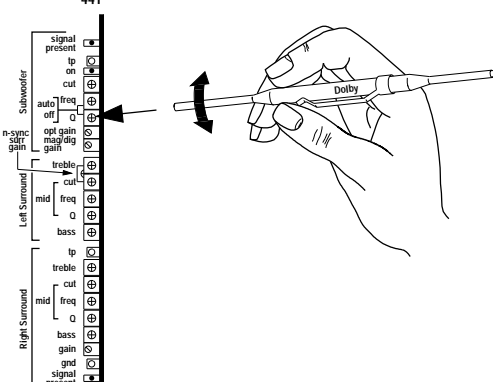
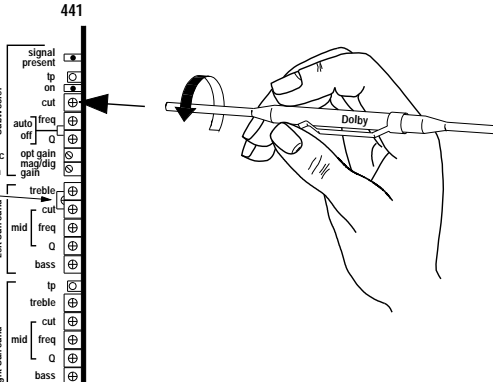
Step No.	Action	Indication
<p>4</p>	<p>Cat. No. 441</p> 	<p>90 dBC → 85 dBC</p> 
<p>5</p>	<p>Cat. No. 441</p> 	
<p>6</p>	<p>Cat. No. 441</p> 	
<p>7</p>	<p>Cat. No. 441</p> 	

Cat. No. 441 Alignment Instructions from the CP65 Manual

Cat. No. 441—Subwoofer Alignment**Notes**

Adjust the **mag/dig gain** control on the Cat. No. 441 card for a 90 dBC SPL (sound pressure level) in the theatre. (If this level cannot be obtained it may be necessary to change the **J2** jumper setting to increase or decrease the output.) When you have obtained this level turn the **mag/dig gain** control **down** for an 85 dBC SPL.

Note

This level is only an approximation. Sound pressure level meters are not appropriate for setting accurate levels of narrow band signals. The correct final level will be set later in this procedure using an RTA.

Turn the **cut** control at the top of the Cat. No. 441 card to the fully clockwise (CW) position for minimum cut. This disables the subwoofer equalizer circuit.

Note the frequency of the peak in the response. You will need this information in Step 9 following.

Turn the **Q** control on the Cat. No. 441 card to its mid point (for a moderately wide notch).

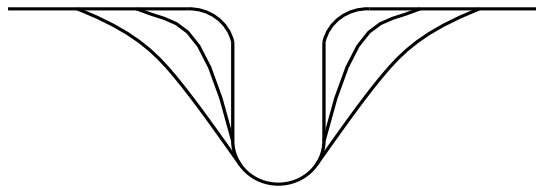

Turn the **cut** control back to the fully counterclockwise (CCW) position for full cut.

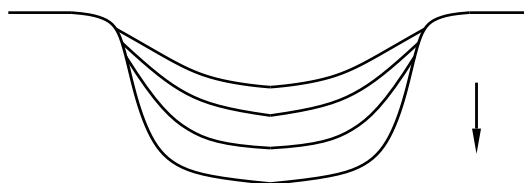

Cat. No. 441 Alignment Instructions from the CP65 Manual

Cat. No. 441—Subwoofer Alignment

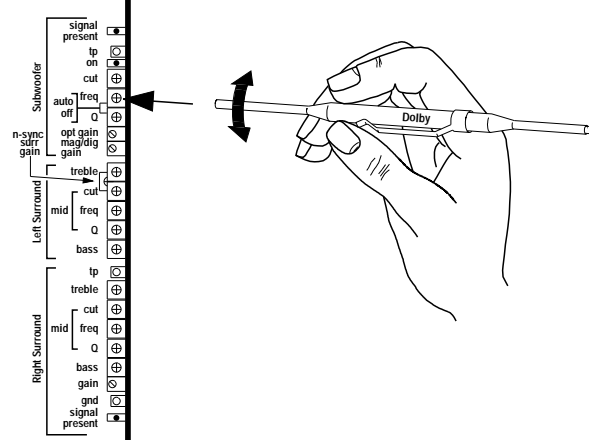
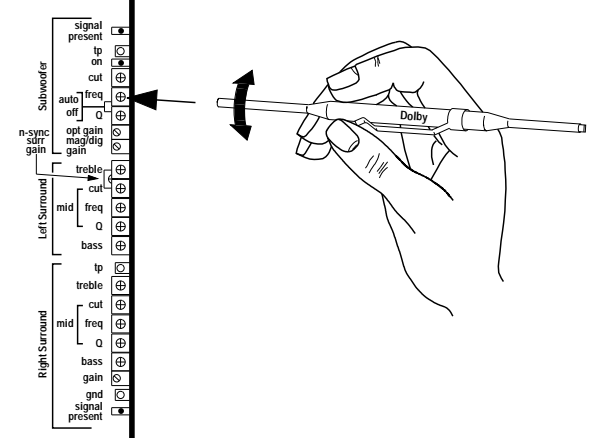
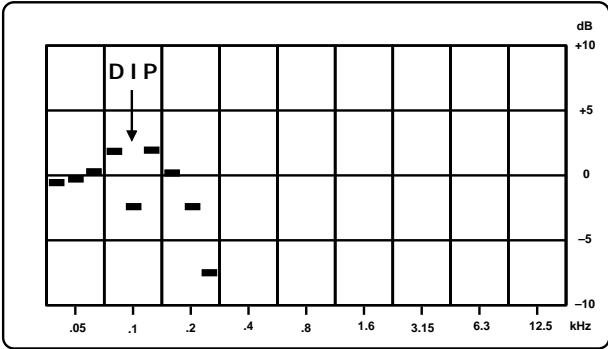
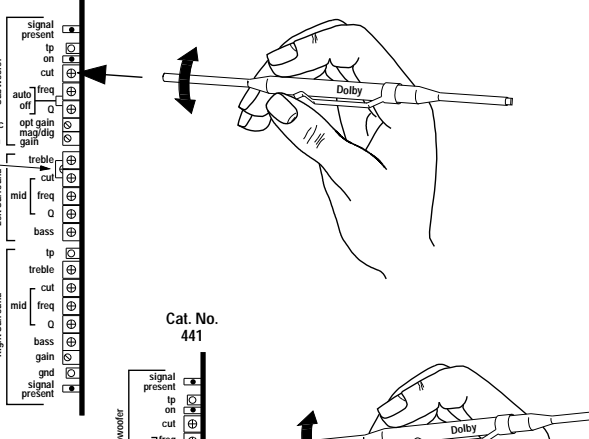
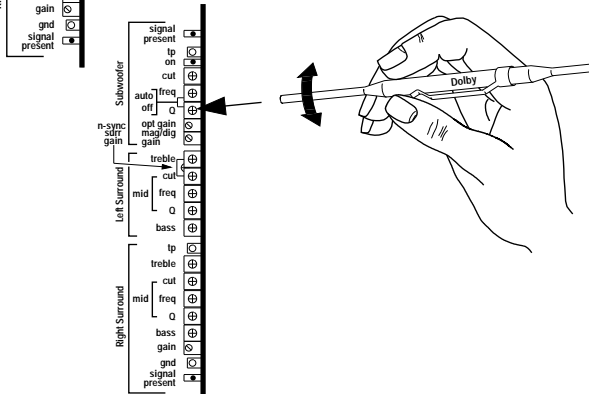
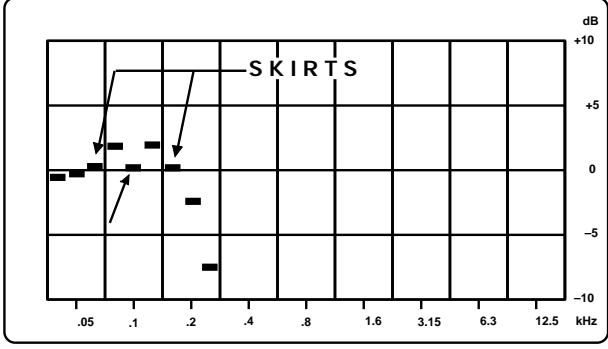
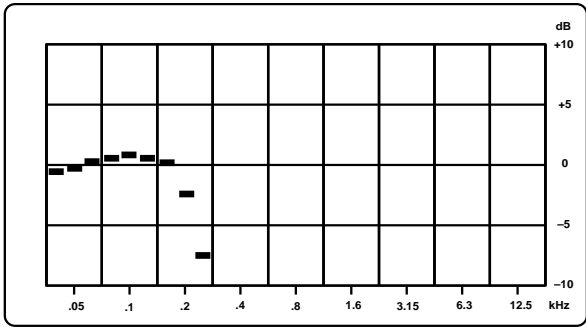
Step No.	Action	Indication
<p>8</p>	<p>Cat. No. 441</p> 	
<p>9</p>	<p>Cat. No. 441</p> 	
<p>10</p>	<p>Cat. No. 441</p>  <p>Cat. No. 441</p> 	 

Notes

Turn the **freq** control on the Cat. No. 441 card. A dip in the frequency response will move along the frequency axis of the RTA display.

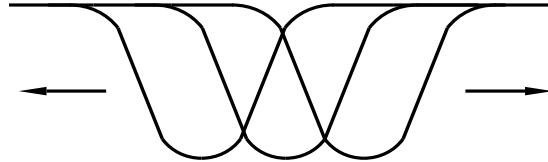

Adjust the **freq** control so the center of the dip is in the same band as the highest peak in the unequalized subwoofer frequency response you were asked to take note of in Step 5.

FROM **5**:

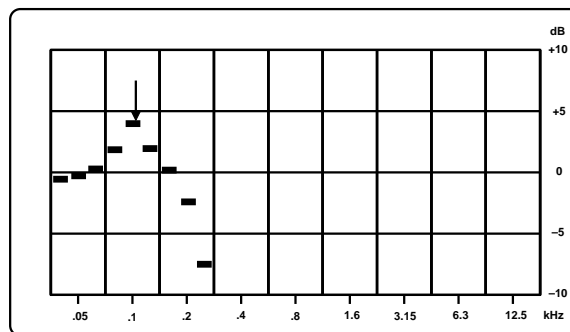

Adjust the **cut** control so the center of the dip flattens. The center of the dip should be at the same level as the skirts.

Adjust the **Q** control for the flattest possible frequency response.

Cat. No. 441 Alignment Instructions from the CP65 Manual

Cat. No. 441—Subwoofer Alignment

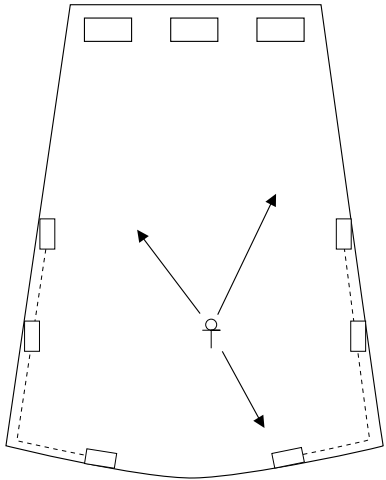
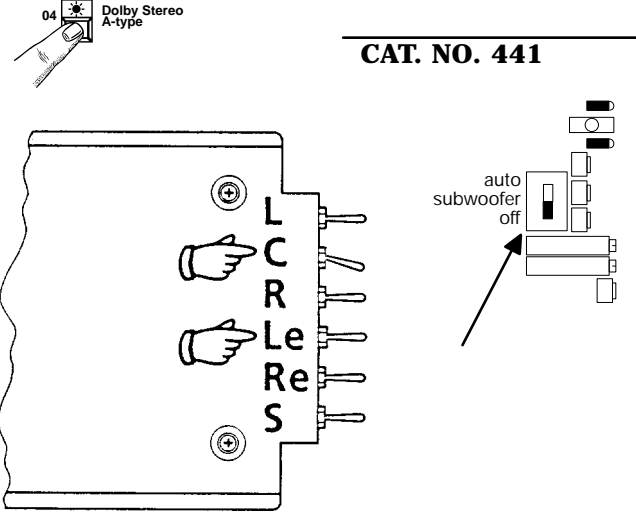
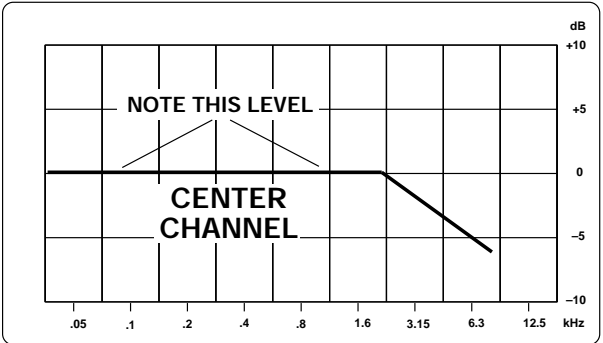
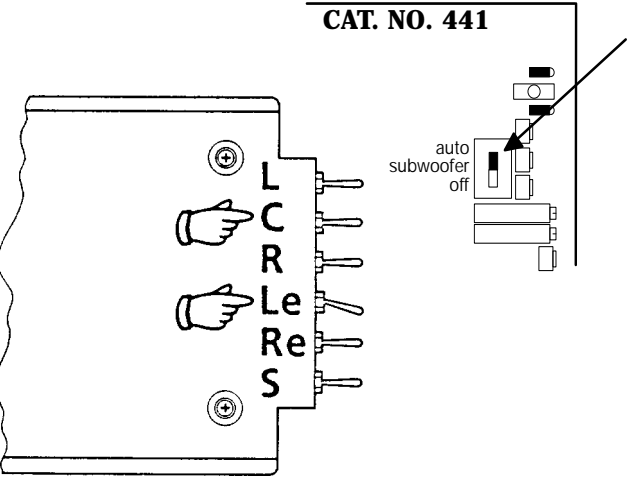
Step No.	Action	Indication
<p>11</p>	 <p>REPEAT 8 → 10</p>	
<p>12</p>	 <p>04 Dolby Stereo A-type</p> <p>CAT. NO. 441</p> <p>auto subwoofer off</p>	 <p>dB</p> <p>+10</p> <p>+5</p> <p>0</p> <p>-5</p> <p>-10</p> <p>NOTE THIS LEVEL</p> <p>CENTER CHANNEL</p> <p>.05 .1 .2 .4 .8 1.6 3.15 6.3 12.5 kHz</p>
<p>13</p>	 <p>CAT. NO. 441</p> <p>auto subwoofer off</p>	

Notes

If using a single microphone, relocate the microphone to at least one other location in the theatre and check the audio spectrum on the RTA. Repeat the freq, cut, and Q adjustments to obtain a good average overall equalization at these locations of the microphone.

Select format **04 Dolby Stereo A-Type**.

Place the **Le** toggle switch on the Cat. No. 85C card in the **OFF** (center) position and place the **C** (center channel) toggle switch in the **ON** position.

Place the subwoofer switch on the Cat. No. 441 in the **OFF** position.

Note the average level of the third-octave bands between 100 Hz and 1 kHz.

Place the **C** toggle switch in the **OFF** (center) position and place the **Le** toggle switch in the **ON** (up or down) position.

Place the subwoofer switch on the Cat. No. 441 in the **auto** position.

Cat. No. 441 Alignment Instructions from the CP65 Manual

Cat. No. 441—Subwoofer Alignment

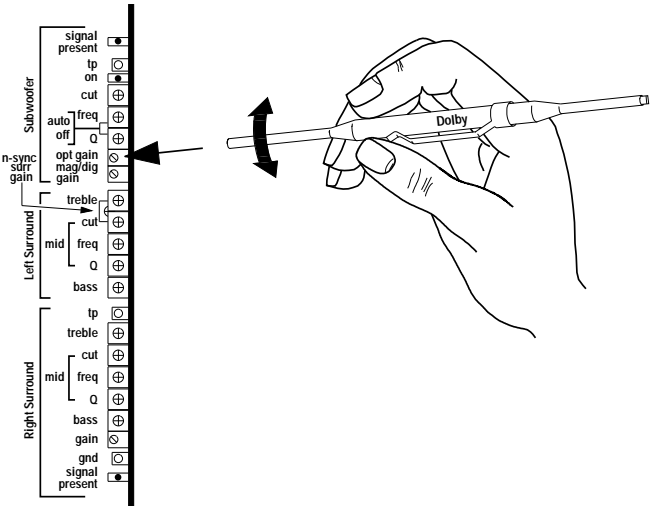
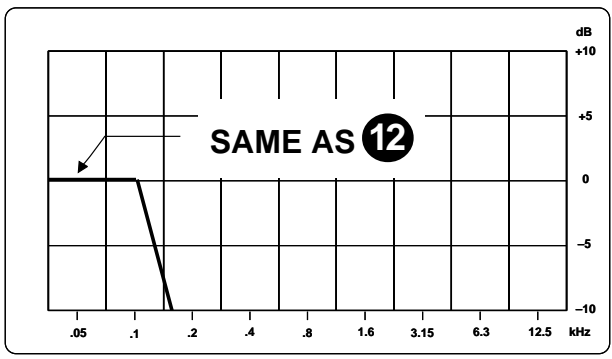
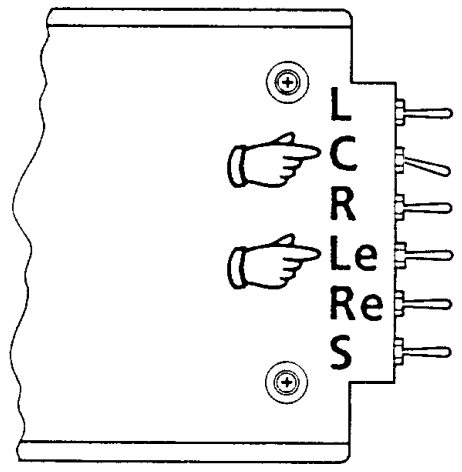
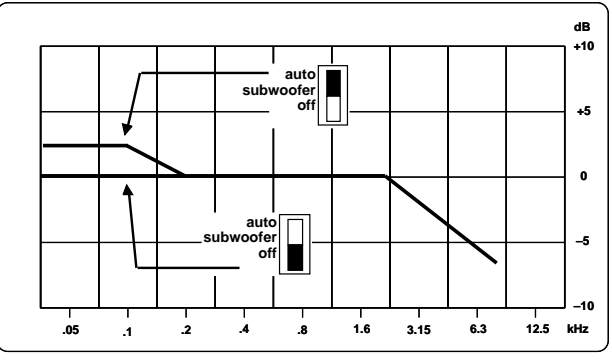
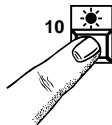
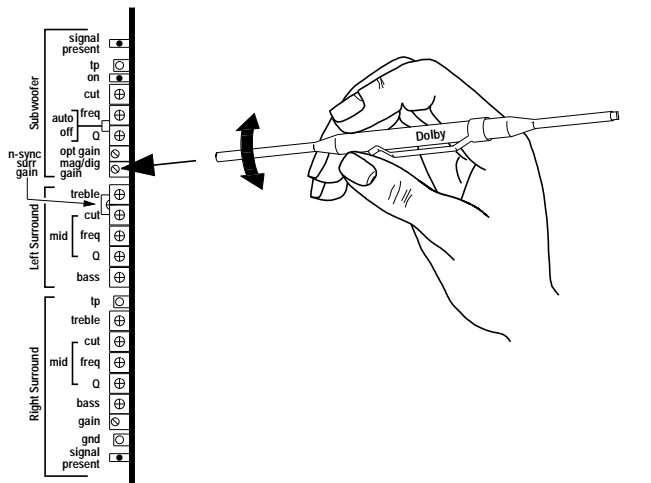
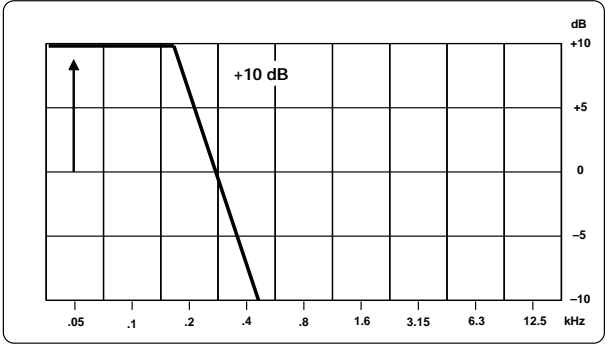
Step No.	Action	Indication
<p>14</p>	<p>Cat. No. 441</p> 	
<p>15</p>		
<p>16</p>	<p>10  Dolby Stereo Digital</p> <p>Cat. No. 441</p> 	

Notes

Adjust the **optical gain** control on the Cat. No. 441 card so that the average level of the bands from the subwoofer is at the same level on the analyzer screen as you noted for the center channel in the previous step.

Place the **Le** toggle switch on the Cat. No. 85C card in the **OFF** (center) position and place the **C** (center channel) toggle switch in the **ON** position.

Note the change in the average level of the bands from 20 Hz to 100 Hz when the subwoofer switch on the Cat. No. 441 is switched between **OFF** and **AUTO**. There should be a level **INCREASE** when it is switched to **AUTO**. The subwoofer is out of phase with the front channels if you do not see this level increase. Reverse the subwoofer(s) speaker connections.

Re-select Format 10.

Adjust the **mag/dig gain** on the Cat. No. 441 so that the level of the bands from the subwoofer increases 10 dB above the level in the previous step.

The subwoofer alignment is completed.

Cat. No. 441 Alignment Instructions from the CP65 Manual

Cat. No. 441—Surround Equalization Alignment

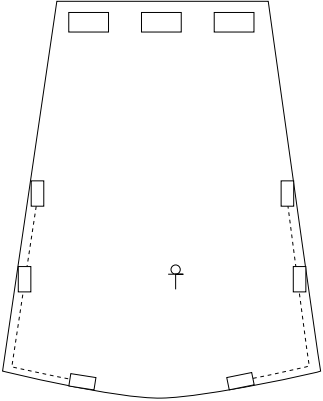
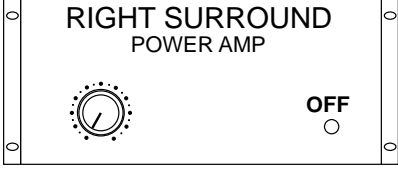
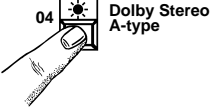
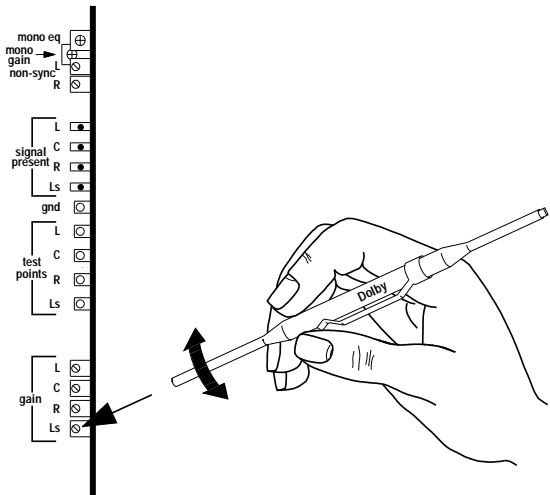
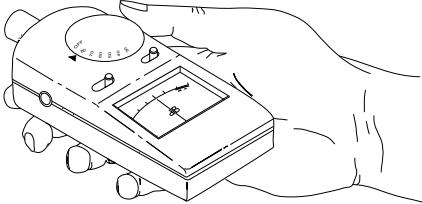
Step No.	Action	Indication
<p>1</p>		
<p>2</p>		
<p>3</p>	 <p>Cat. No. 242</p> 	<p>MONO SURROUND STEREO SURROUND</p> <p>88 dBC 85 dBC</p> 

Cat. No. 441 Alignment Instructions from the CP65 Manual

Cat. No. 441—Surround Equalization Alignment**Notes**

The surround equalizer on the Cat. No. 441 card consists of:

- A parametric mid-band section with variable cut, bandwidth, and center frequency.
- Shelving type Bass and Treble controls.

All connections established in the previous procedure still apply to the surround equalization alignment. Confirm that the microphone is in the position defined earlier. Ensure that format 04 is selected.

Note: The Cat. No. 441 can be configured for either Mono or Stereo surround operation using link **J3**. If Mono operation is selected then an identical signal will be fed to both **Ls** and **Rs** outputs in all formats. If only one power amplifier is to be used for the surround channel then the **Ls** should be used. If more than one surround amplifier is to be used, both outputs may be used to feed, for example, balcony and ground floor. The separate level controls and equalizers may then be used to compensate for differences caused by the different acoustic environments of the two areas. If stereo operation is selected a stereo surround signal will be fed to the surround channels when format 10, Dolby Digital is selected.

If the surround speakers are wired for stereo operation or both surround outputs are in use switch off (or disconnect the input to) the right surround amplifier or amplifiers.

Turn on the **S** switch on the Cat. No. 85C pink noise generator. Be sure that format 04 is selected.

Adjust the **Ls** (left surround) **gain** control on the Cat. No. 242 B-Chain card for a sound pressure level of approximately 85 dBC in the theatre. If only one surround output is used set the level to 88 dBC.

Cat. No. 441—Surround Equalization Alignment

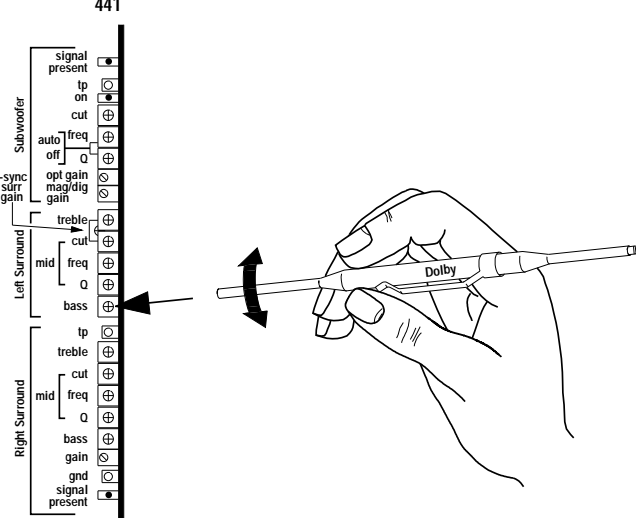
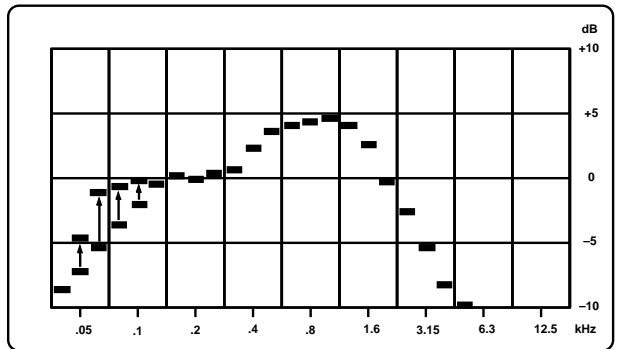
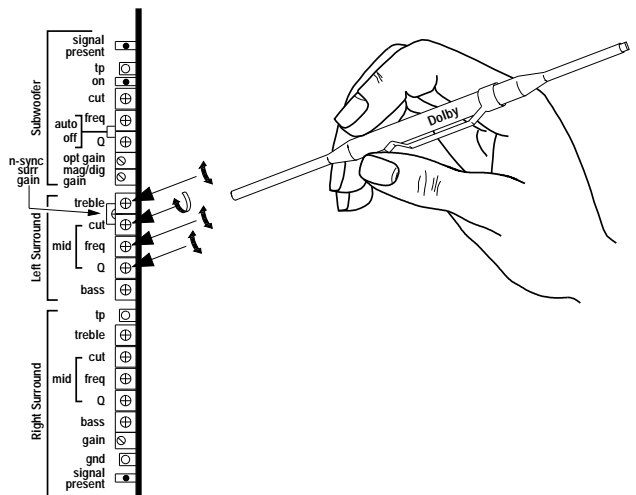
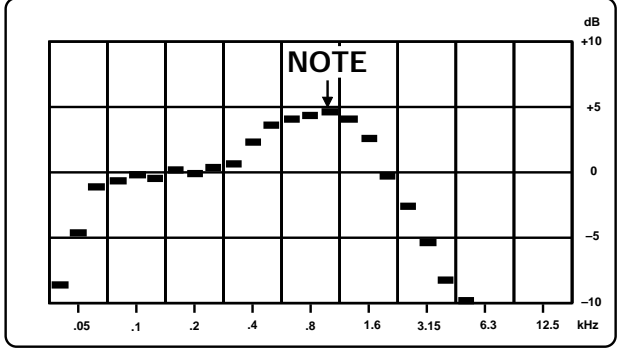
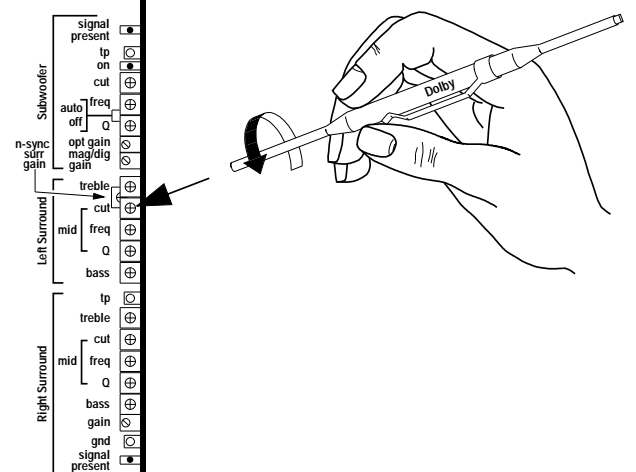
Step No.	Action	Indication
<p>4</p>	<p>Cat. No. 441</p> 	
<p>5</p>	<p>Cat. No. 441</p> 	
<p>6</p>	<p>Cat. No. 441</p> 	

Cat. No. 441—Surround Equalization Alignment**Notes**

Adjust the **Left Surround bass control** on the Cat. No. 441 card for as flat as possible low frequency response on the RTA. Use caution when adjusting the bass control; many surround loudspeaker systems are deficient in their low frequency response. Attempts to boost the output of such system beyond their capabilities simply wastes amplifier power and can result in distortion and possibly damage to the surround loudspeakers.

Adjust the **Left Surround treble control** to its mid point, so that it provides neither cut nor boost.

Adjust the mid frequency controls as follows: Turn the **Cut** control fully clockwise (CW). Set the **Q** and **freq** controls to their mid positions.

Note the position of the center of the highest frequency peak in the 350 Hz to 3 kHz region on the analyzer screen.

Turn the **Cut** control fully counterclockwise and note the position of the notch produced by the equalizer.

Cat. No. 441—Surround Equalization Alignment

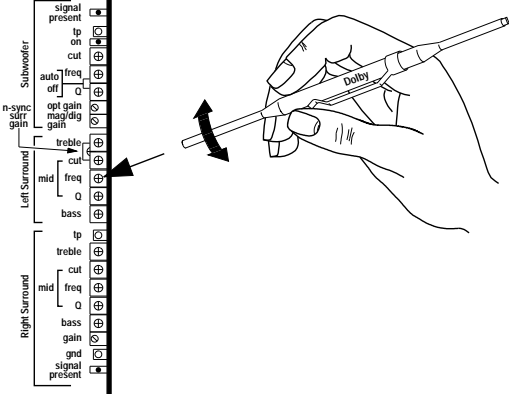
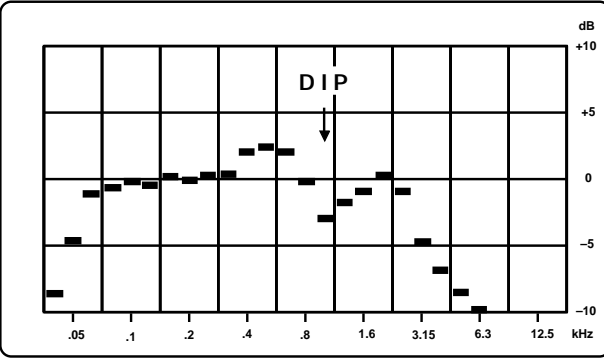
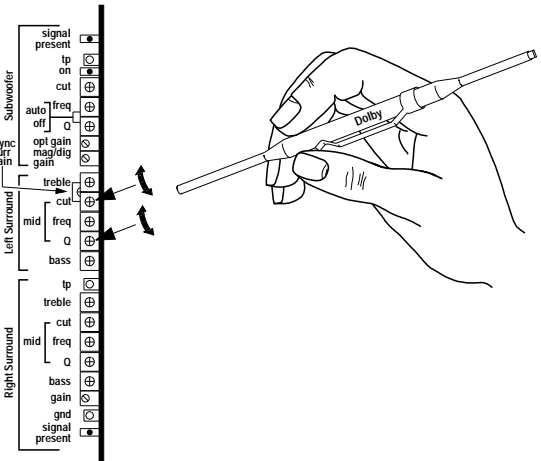
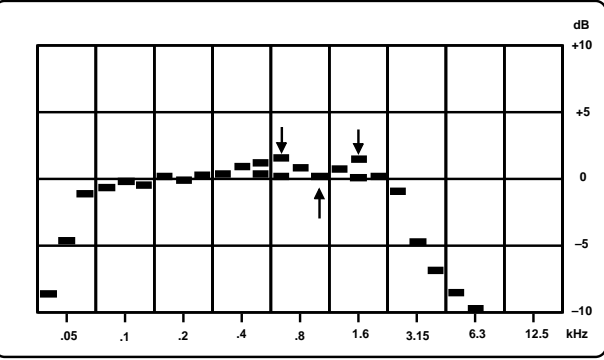
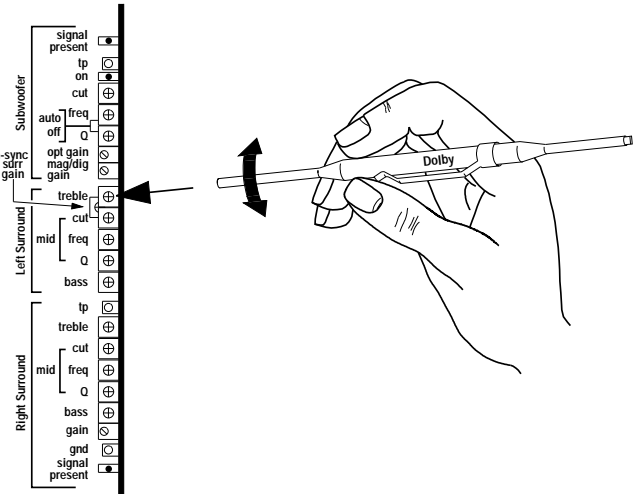
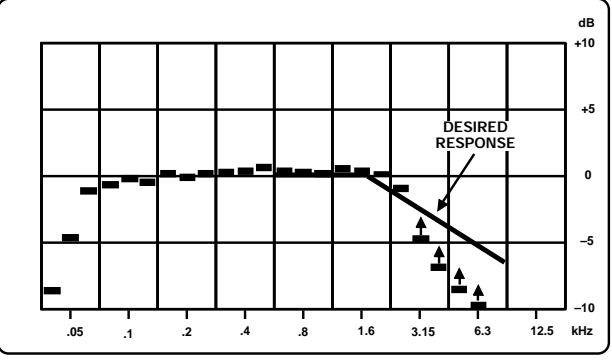
Step No.	Action	Indication
7	<p>Cat. No. 441</p> 	
8	<p>Cat. No. 441</p> 	
9	<p>Cat. No. 441</p> 	
10	<p>REPEAT 7 → 9</p>	

Cat. No. 441—Surround Equalization Alignment**Notes**

Turn the **freq** control so that the notch is located over the peak noted in the previous step.

Adjust the **Cut** and **Q** controls for the flattest response in this part of the spectrum.

Adjust the **treble** control on the Cat. No. 441 card for the best approximation to the desired response shown.

The treble and mid equalizer controls interact. Repeat the adjustments until no further adjustment is required and you have attained the optimum frequency response.

Cat. No. 441—Surround Equalization Alignment

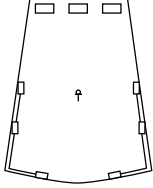
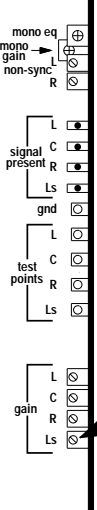
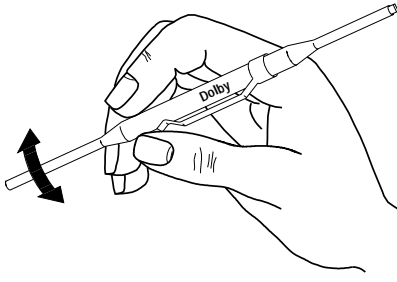
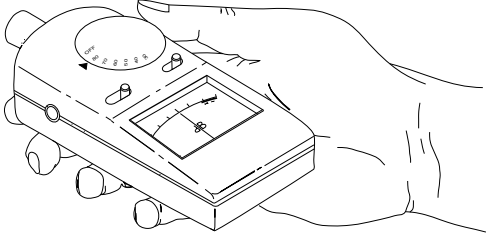
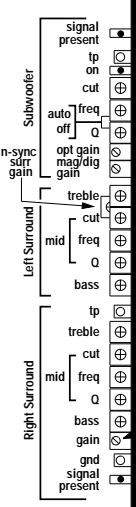
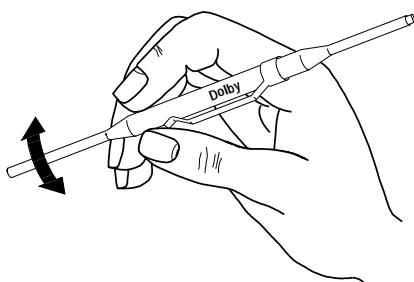
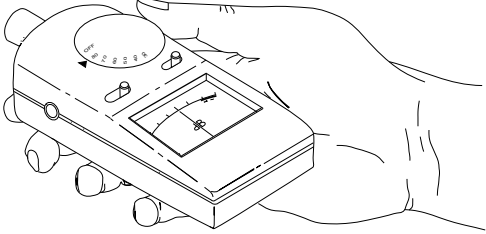
Step No.	Action	Indication
<p>11</p>	 <p>Cat. No. 242</p>  	<p>MONO SURROUND STEREO SURROUND</p> <p>88 dBC 85 dBC</p> 
<p>12</p>	<p>RIGHT SURROUND AMP</p> <p>ON</p> <p>LEFT SURROUND AMP</p> <p>OFF</p>	
<p>13</p>	<p>Cat. No. 441</p>  	<p>85 dBC</p> 
<p>14</p>	<p>REPEAT 4 → 11</p>	

Cat. No. 441—Surround Equalization Alignment**Notes**

Adjust the **Ls** (Left surround) gain control on the Cat. No. 242 B-Chain card for a sound pressure level of 85 dBC (or 88 dBC if only one surround output is to be used).





If the surround speakers are wired for stereo operation or both surround outputs are in use, switch **on** (or reconnect the input to) the **right surround** amplifier or amplifiers. Switch off (or disconnect the input to) the Left surround amplifier or amplifiers.

With the microphone still located at the center of the theatre, adjust the **Right Surround gain** control on the Cat. No. 441 surround and subwoofer card for a sound pressure level of 85 dBC.

Repeat Steps 4 through 11 using the **Right Surround** pots on the Cat. No. 441 card.
NOTE: When you reach Step 11 remember that the right surround gain control is located on the Cat. No. 441 board.

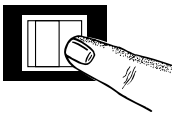
Cat. No. 441 Alignment Instructions from the CP65 Manual

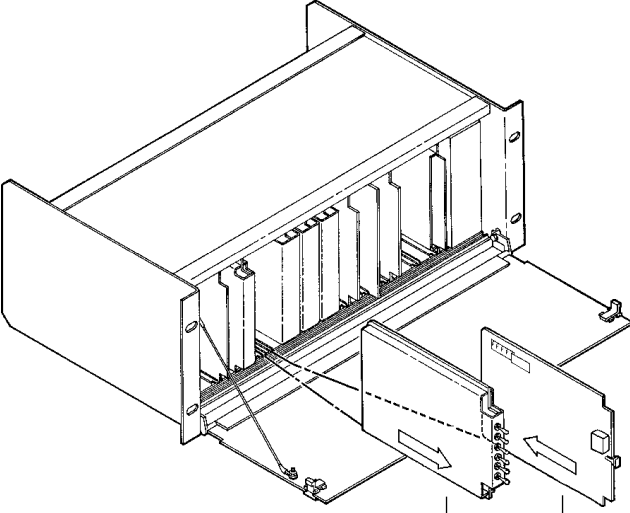
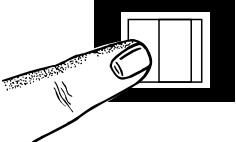
Cat. No. 441—Surround Equalization Alignment

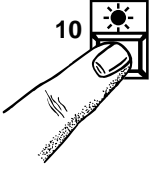
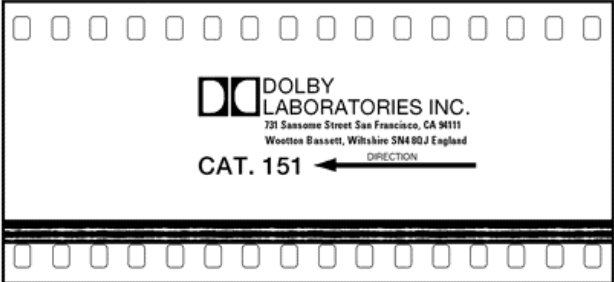
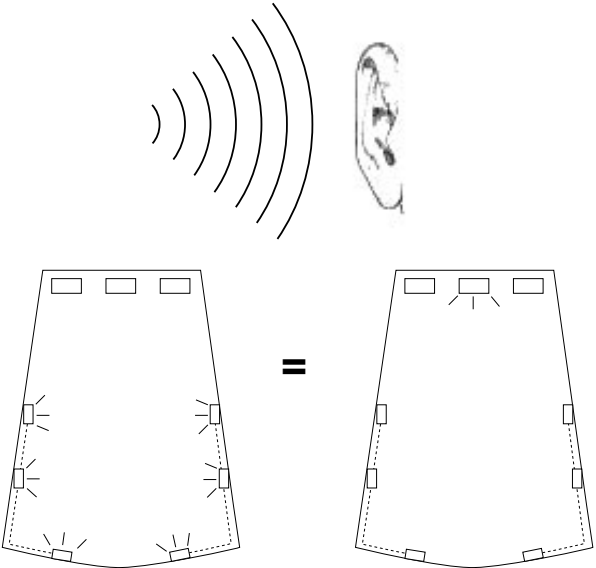
Step No.	Action	Indication
15	<p>NORMAL BYPASS</p> 	<p>bypass  (switch behind panel)</p>
16	 <p>Cat. No. 85 Cat. No. 150</p>	
17	<p>NORMAL BYPASS</p>  <p>10  Dolby Stereo Digital</p> 	
18		

Cat. No. 441—Surround Equalization Alignment**Notes**

Open the CP65 and place the **NORMAL/BYPASS** switch in the **BYPASS** position.

Remove the Cat. No. 85C card and re-install the Cat. No. 150 card.

Restore the **BYPASS/NORMAL** switch to the **NORMAL** position.

Confirm that format **04 Dolby Stereo A-Type** is selected.

Thread and play the Cat. No. 151 stereo optical surround level film. Check the sound by walking around the theatre. The surround and center channels should sound equally loud at most locations and left and right surround channels should sound equally loud and have similar frequency response in the center of the theatre. If necessary, readjust the left and right surround gains until you are satisfied with the surround-to-front center balance. A large change in the gain setting should be unnecessary.

2.5.2 Installation of DA20 with CP65

Refer to the CP65 wiring diagram fold-out, Figure 2.10. Two cable assemblies are furnished in the CP65 kit. The ribbon cable with D-connectors on each end connects from J6 on the DA20 to J18 on the CP65. The round cable plugs into J8 on the DA20 and the fanning strip on the other end connects to TB4 as shown.

Audio from DA20 to CP65

DA20 CP Audio Conn. J8 (DB25 Male) Pin no.	CP65 TB4 "From Digital" Terminal no.
1 AGND	GND
2 Rs out	Rs
3 AGND	
4 AGND	
5 AGND	
6 AGND	
7 AGND	
8 AGND	
9 AGND	
10 AGND	
11 AGND	
12 AGND	
13 AGND	
14 L out	L
15 Ls out	Ls
16 Re out	
17 R out	R
18 Le out	
19 n.c.	
20 C out	C
21 S out	
22 n.c.	
23 n.c.	
24 SW out	S/W
25 Spare out	

CP65 to DA20 Sense/Control

Format sense and control is accomplished via connection of CP S0 through S7 lines, connected to DA20 CTRL0 through CTRL7. The DA20 monitors CTRL lines and asserts formats depending on the mode of operation of the DA20. Valid format assertions are detected when any one CTRL line is low for greater than 80ms. See the DA20 Users' Manual for specific information related to the DA20 modes of operation and the Auto Digital feature.

The DA20 switches to format 05 by holding CTRL2 low for approximately 150ms and returns to format 10 by holding CTRL 4 low for approximately 150ms. (The CP65 requires about 50ms to switch formats.)

DA20 J6 DB25 Male Pinout	CP55 J18 DA25 Female Pinout
1 Ctrl0	S0 (01 - mono optical)
2 Ctrl1	S1 (04 - Dolby Stereo)
3 Ctrl2	S2 (05 - Dolby SR)
4 Ctrl3	S3
5 Ctrl4	S4 (10 - Dolby SR'D)
6 Ctrl5	S5
7 Ctrl6	S6
8 Ctrl7	S7 (20 - aux/mag.)
9 n.c	
10 n.c	
11 n.c	-15V
12 GND	GND
13 n.c	+15V
14 Sense0	ID0 (status lines)
15 n.c.	ID1
16 n.c.	ID2
17 n.c.	ID2
18 n.c.	ID4
19 n.c.	ID5
20 n.c.	ID6
21 n.c.	ID7
22 n.c.	n.c
23 n.c.	n.c
24 n.c.	n.c
25 C/O Status	Changeover Status

2.5.3 Installation of DA20 with CP200

Refer to the CP200 wiring diagram fold-out, **Figure 2.11**. The lengths of cable in the wiring harnesses furnished assume that the DA20 will be mounted directly above the CP200 and associated MPU. It will be necessary to remove and set aside the ribbon jumper cable that goes from CP200 JM11 to JM21. **Note that removing this jumper interrupts the signal path for all channels except the subwoofer. If the DA20 is subsequently removed for any reason, the D-connectors at the ends of the new cables that connect to JM11 and JM21 must be connected to each other to re-establish the audio path.**

In addition to the audio signal connections, the control logic must be connected between the units. These connections are shown in Figure 2.11.

In order for the auto digital feature to operate, the DA20 must be equipped with a Cat. No.611A card. The DA20 also needs the ability to assert each of the four CP200 format selections to determine which format selector is assigned format 10 and when detected, assert format 10 when appropriate. This is accomplished via the Cat. No. 493 Auto Digital Adapter card which is mounted to connector BS21 on the rear panel of the CP200 Control unit. The Cat. No. 493 contains the circuitry required to allow the DA20 to assert each of the four format selections and to feed back when format 10 is detected.

Additionally, there are four wires which must be either soldered to or attached to barrier strips on the CP200 control unit backplane. See the information supplied with the Cat. No. 493 card for details on attachment of these wires.

In order for the subwoofer to work with the DA20, a replacement for the Cat. No.160 is required. This card is called the Cat. No.560 and is based on the Cat. No.441 subwoofer and surround card used in the CP65. In addition to subwoofer processing, it offers two channels of surround equalization.

To make full use of the available dynamic range of the Dolby Digital format, the CP200 requires an improved output fader card. The Cat. No.517 has been designed to fulfill this requirement and its installation in any CP200 used to play Dolby Digital films is highly recommended.

Backplane modifications for Cat. Nos.560 and 517 are shown in Figure 2.14 or 2.15.

The Cat. No. 153 Optical Format card from the CP200 control unit must be modified to allow the DA20 to detect the assertion of the various film formats and thus assert format 10 when appropriate depending on the operating mode of the DA20. The programming of the Optical Format card assumes that an SRA5 is installed with the CP200 for proper reversion to the Dolby SR analog soundtrack.

Remove the Cat. No.153 Optical Format Card from the CP200 Control Unit and install the diodes as follows:

Format Bus Lines	1,4,13,17,26,29,31
Diode Locations	98,103,112,116,125,128,292,388,484

Use a low wattage soldering iron and ensure that there are no solder bridges when finished. Inspect the installed diodes for correct polarity. Reinstall the Cat. No.153 in the CP200 control unit.

2.5.3.1 Cat. Nos. 517, 137L, and 560 Installation and Operation Instructions (CP200)

The Cat. Nos. 517 and 560 are designed to replace the Cat. Nos. 117 and 160, respectively. Their primary purpose is to upgrade the CP200 cinema processor to handle the wider dynamic range, lower distortion signals now available from Dolby Digital. They offer improved performance even if simply plugged in place of the older cards, and additional features are available if a few wires are added to the CP200 backplane. Block diagrams of both cards are included with this set of instructions (Figures 2.16 and 2.17). Note that the installation procedure in a CP200 varies depending upon whether or not the system is equipped with an accessory unit containing Cat. No.64 equalizers for the P and Q channels.

Features Of The New Cards

The Cat. No.517 VCA and Line Amp card offers reduced distortion and a considerable headroom increase over the Cat. No.117. The increase in headroom is particularly useful when the cards are installed in a system using Altec A-series loudspeakers or modern loudspeakers with passive crossovers. This is because the large treble boost required for the screen channels can be selected in the output stage of the Cat. No.517 rather than in the Cat. No.64 1/3-octave equalizers. When this feature is used, the Cat. No.64s must of course be re-aligned.

The Cat. No.517 is equipped with four signal presence LEDs located at the input to the card. The LEDs will illuminate if the signal level is 15 dB below Dolby level or higher.

The Cat. No.137L is a link card that replaces the Cat. No.137. The Cat. No.137L must be used in conjunction with Cat. No.517s, or incorrect gains and high noise levels will result.

The Cat. No.560 Surround/Subwoofer Dolby Digital card replaces the Cat. No.160 and provides a dedicated subwoofer channel input for use with digital films and jumper selectable low-pass frequencies for both optical and magnetic film formats. Used with Cat. No.517s as part of the Dolby Digital upgrade package, it provides parametric equalization for the P (Left surround) and Q (Right surround) channels.

Cat. No. 517 Jumper Settings

Each of the two Cat. No.517 has five programming jumpers and three switches:

- **S1 through S3** select a fixed treble boost (9 dB at 5 kHz, 14 dB at 10 kHz) designed to approximate the large treble equalization required with many screen speakers. Up is on, down is off. Note that this boost (called treble compensation to distinguish it from other kinds of eq.) is available only for screen channels. Neither P (Left surround) nor Q (Right surround) channels have this boost feature, and this circuit is disabled in the left slot of the CP200 for the S channel.
- **J1 through J4** select high or low output gain ranges for the four channels on the card. The HIGH/LOW selectors on the CP200 Backplane must be left in the HIGH position at all times for best performance and the gain range jumpers on the cards used instead.

The CP200 output section actually has three signal paths for surround channel signals-S, P (Left surround), and Q (Right surround). In a normal monaural surround installation, only the S output is used. In installations configured to play 70 mm stereo surround films (format 43), the P (Left surround) and Q (Right surround) outputs are normally used and the S output ignored.

In some theaters the S output is used to feed rear wall speakers or balcony speakers so as to have three separate zones with separate level controls. In a stereo surround system, it is best to re-allocate these speakers to the P (Left surround) and Q (Right surround) channels as appropriate. (However, where this is not practical, in the DA20 a mono surround output created by summing the left and right surround signals is provided and is routed to the S output channel in the CP200.)

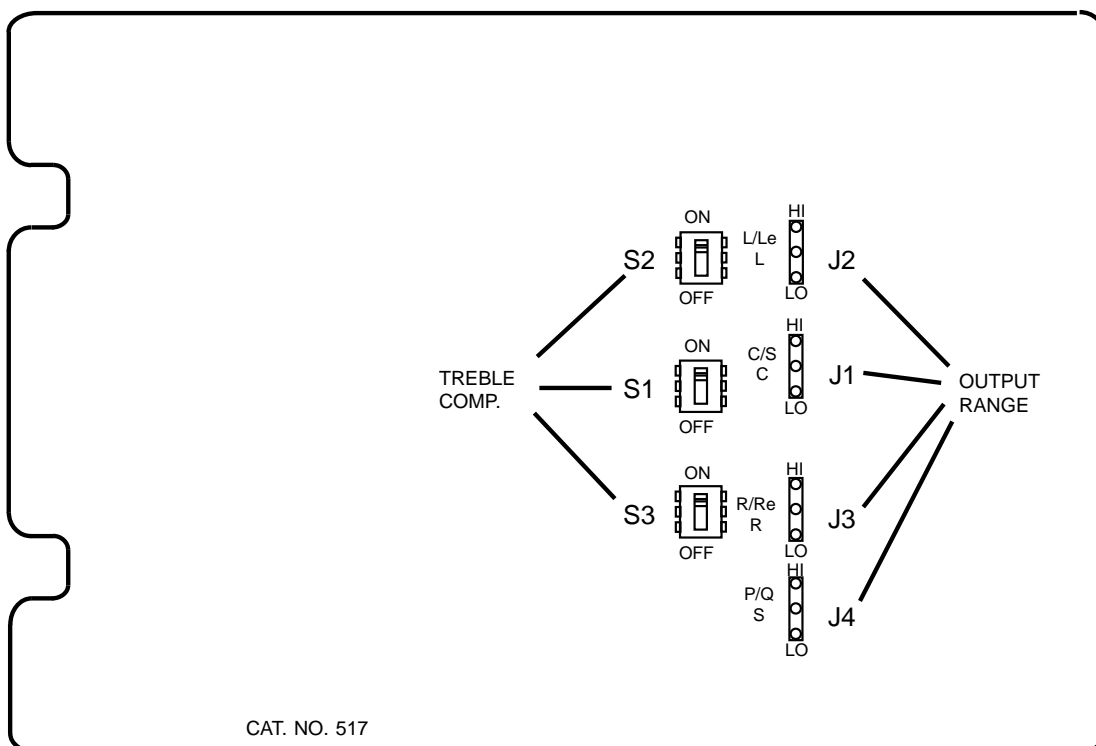

Figure 2.12 Cat. No.517 Jumper Settings

Cat. No. 560 settings

The Cat. No.560 has six programming jumpers and one switch on it:

- **J1** selects high or low output level range for the CP50 Right surround output.
- **J2** selects high or low output level range for the subwoofer channel.
- **J3** selects the surround logic mode. Set to the CP200 position.
- **J4** selects either a 50 or 100 Hz low-pass filter for the subwoofer when in analog optical formats. The 50 Hz setting is intended for use with JBL, E-V or other modern screen loudspeakers having good response and power handling down to that frequency. By using this filter position, overlap between subwoofer and screen speakers is avoided. The 100 Hz setting is intended for use with Altec A-series and other older screen speakers lacking in power handling ability at low frequencies. In these cases, the screen speaker equalization should not have boost applied below 100 Hz so as to avoid a peak in the system frequency response caused by overlapping outputs from the subwoofer and screen speaker.
- **J5** selects either a 100 or 180 Hz low pass filter for the subwoofer in magnetic sound formats. The 180 Hz position is intended for installations with no Le or Re speakers, where the subwoofer carries all bass track information. The 100 Hz position is intended for installations using the Le and Re speakers to carry the bass track information in conjunction with a subwoofer. The Le and Re screen speakers are rolled off below 100 Hz by the Cat. No.142. The subwoofer provides the mid- and low-bass information.
- **J6** disables the CP200 subwoofer output in CP50 installations.
- **S1** enables or disables the subwoofer. The lower position corresponds to the OFF setting on Cat. No.160 and the upper setting to the AUTO setting.

The Cat. No.560 provides a single band parametric equalizer and variable turnover bass and treble controls for P and Q surround channels and a single band parametric equalizer for the subwoofer. The equalizer control functions and locations of the Cat. No.560 are similar to those on the Cat. No.441 card used in the CP65.

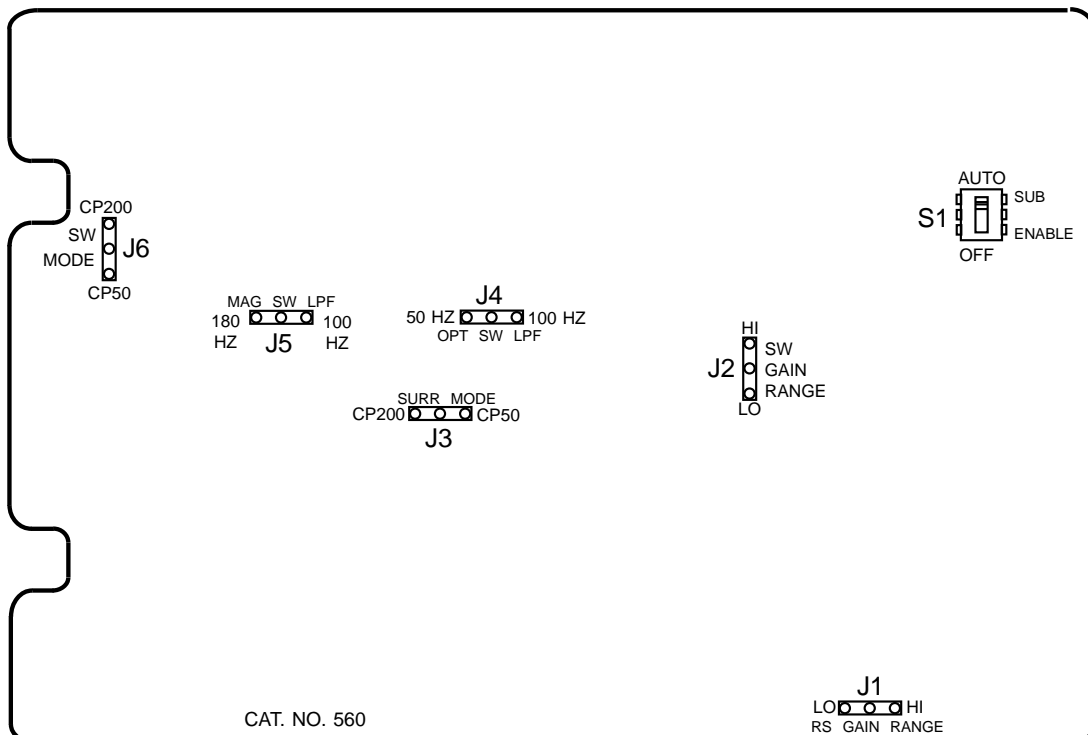

Figure 2.13 Cat. No.560 Jumper Settings

2.5.3.2 Installation of Cat. Nos. 517, 137L, and 560 in CP200 With NO Accessory Unit

Install the wiring shown in the wiring pictorial diagram (Figure 2-14).

Description of backplane wiring (no accessory unit):

FROM	TO	FUNCTION	FIGURE REF.
SK30 pin A (Cat. No. 517)	SK28 pin A (Cat. No. 517)	optical surround trim VCA signal	A
SK30 pin M	SK28 pin M (Cat. No. 517)	Dolby Digital valid logic signal from DA20 (low = valid)	B
SK28 pin M	SK13 pin B21 (Cat. No. 560)	Dolby Digital valid logic signal from DA20 (low = valid)	C
SK 28 pin S	SK28 pin 7 (Cat. No. 517)	Grounds pin S to indicate card is in left slot, disabling C/S channel treble compensation and enabling surround trim pot to control P (Left surround) and Q (Right surround) channels.	D
SK 28 pin J	SK13 pin A13 (Cat. No. 560)	output to Q (Right surround) EQ (not used with Cat. No. 64 surround EQ)	E
SK 28 pin K	SK13 pin B7	return from Q (Right surround) EQ (not used with Cat. No. 64 surround EQ)	F
SK 30 pin J	SK13 pin A5	output to P (Left surround) EQ (not used with Cat. No. 64 surround EQ)	G
SK 30 pin K	SK13 pin B3	return from P (Left surround) EQ (not used with Cat. No. 64 surround EQ)	H

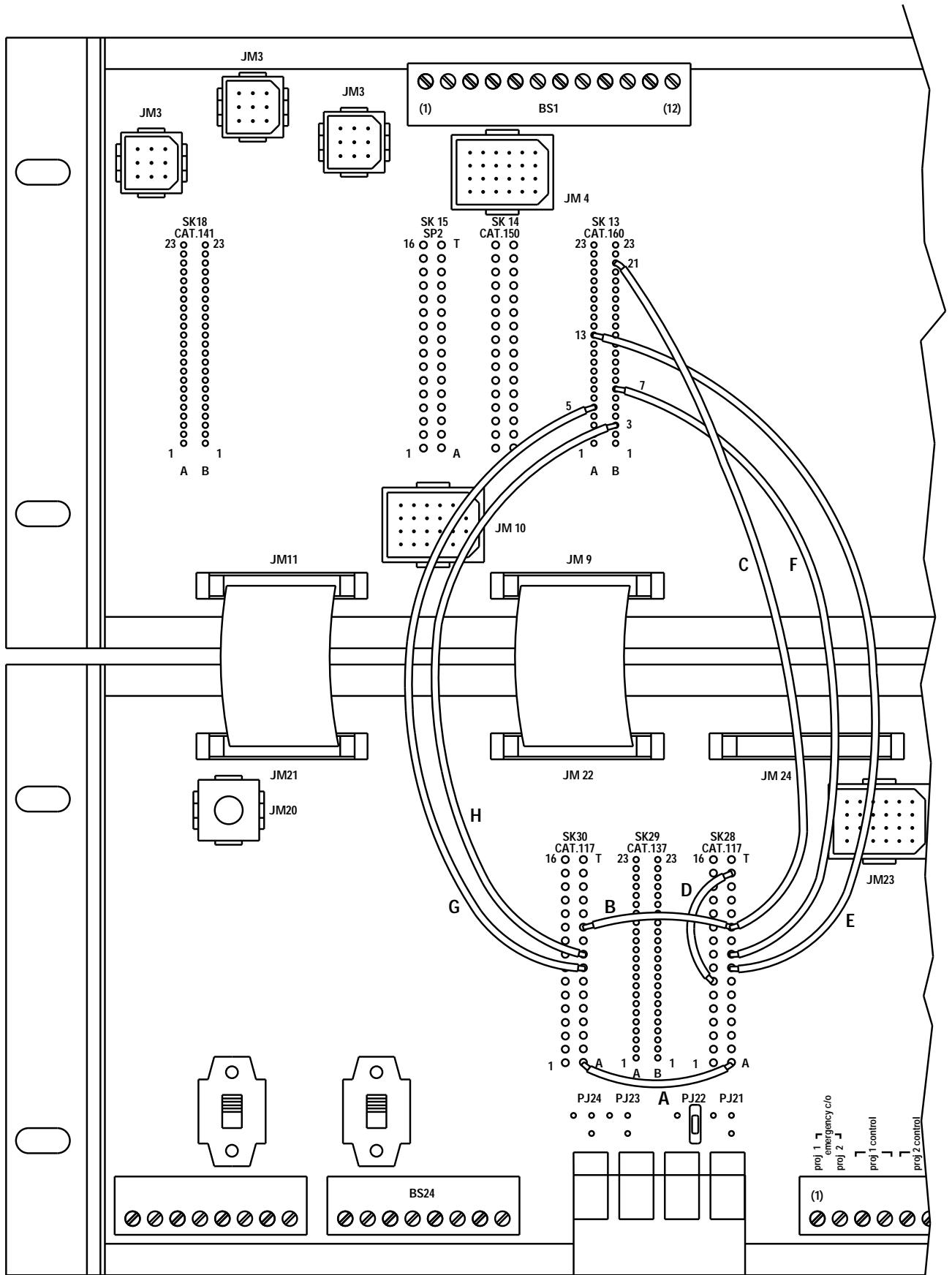

Figure 2.14 CP200 Backplane Wiring (no accessory unit)

When the backplane wiring is done as shown in the figure, the operation of the Cat. No.517s for the S, P (left surround), and Q (right surround) channels is as follows:

The optical surround trim (the upper pot on the left-hand Cat. No.517) now functions as a surround trim governing all three surround outputs at once when an analog optical format with surround (formats 04 or 05) is selected. A range of ± 10 dB around the nominal setting is provided. In all other formats, this pot is disabled.

When no accessory unit is installed the surround EQ sections of the Cat. No.560 are used to equalize the P and Q channels (the S channel will not be equalized). Select format 40 (70 mm mag, no NR). Remove the Cat. No.141 from slot 37 of the CP200 processor unit (first slot in from the right) and insert the Cat. No.85 Pink Noise Generator in its place. Be sure to mute the processor when removing or inserting a card. **Note: the Center switch on the Cat. No.85 will send pink noise to P (left surround) and the Surround switch will send it to Q (right surround).**

Use a calibrated microphone and a real time analyzer (RTA) to equalize the surround channels according to the following instructions (from the CP65 manual). The instructions explain the alignment of a Cat. No.441 card, however the Cat. No.560 **EQ section** is identical. References to gain settings (on Cat. No.242) should be interpreted to be Cat. No.517 gain settings.

After completing these steps, reinstall the Cat. No.141 into slot 37 and proceed to the section **Equalization of the Subwoofer Channel (Section 2.4.3.4).**

No text on this page.

Surround EQ Alignment Instructions from the CP65 Manual

Cat. No. 441—Surround Equalization Alignment

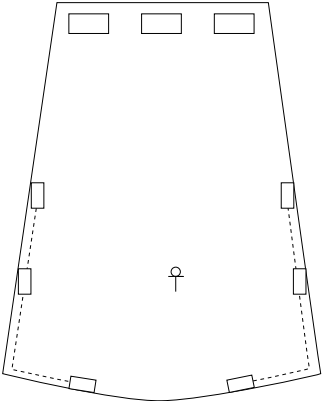
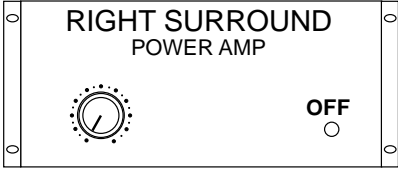
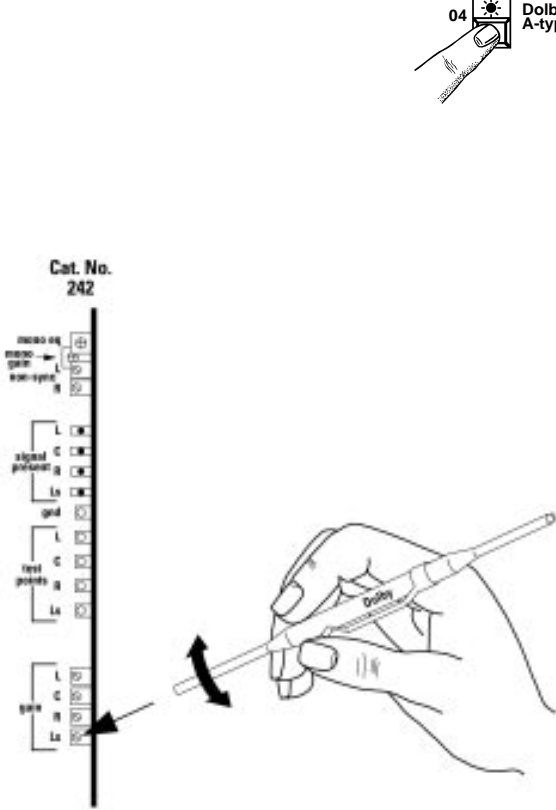
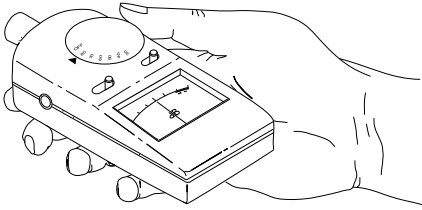
Step No.	Action	Indication
<p>1</p>		
<p>2</p>		
<p>3</p>		<p>MONO SURROUND STEREO SURROUND</p> <p>88 dBC 85 dBC</p> 

Cat. No. 441—Surround Equalization Alignment**Notes**

The surround equalizer on the Cat. No. 441 card consists of:

- A parametric mid-band section with variable cut, bandwidth, and center frequency.
- Shelving type Bass and Treble controls.

All connections established in the previous procedure still apply to the surround equalization alignment. Confirm that the microphone is in the position defined earlier. Ensure that format 04 is selected.

Note: The Cat. No. 441 can be configured for either Mono or Stereo surround operation using link **J3**. If Mono operation is selected then an identical signal will be fed to both **Ls** and **Rs** outputs in all formats. If only one power amplifier is to be used for the surround channel then the **Ls** should be used. If more than one surround amplifier is to be used, both outputs may be used to feed, for example, balcony and ground floor. The separate level controls and equalizers may then be used to compensate for differences caused by the different acoustic environments of the two areas. If stereo operation is selected a stereo surround signal will be fed to the surround channels when format 10, Dolby Digital is selected.

If the surround speakers are wired for stereo operation or both surround outputs are in use switch off (or disconnect the input to) the right surround amplifier or amplifiers.

Turn on the **S** switch on the Cat. No. 85C pink noise generator. Be sure that format 04 is selected.

Adjust the **Ls** (left surround) **gain** control on the Cat. No. 242 B-Chain card for a sound pressure level of approximately 85 dBC in the theatre. If only one surround output is used set the level to 88 dBC.

Surround EQ Alignment Instructions from the CP65 Manual

Cat. No. 441—Surround Equalization Alignment

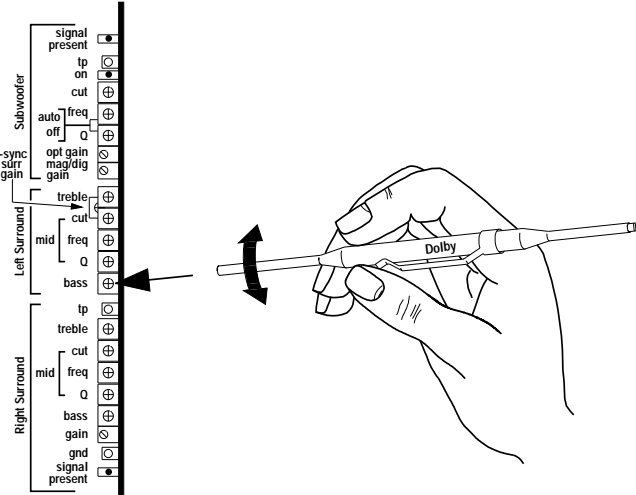
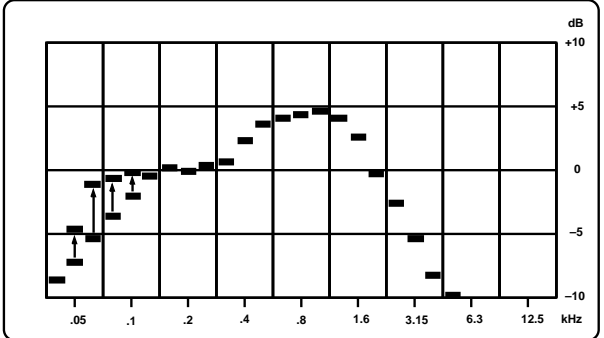
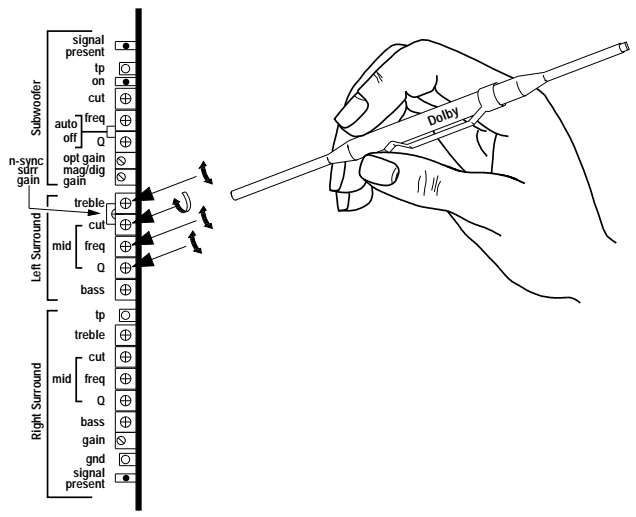
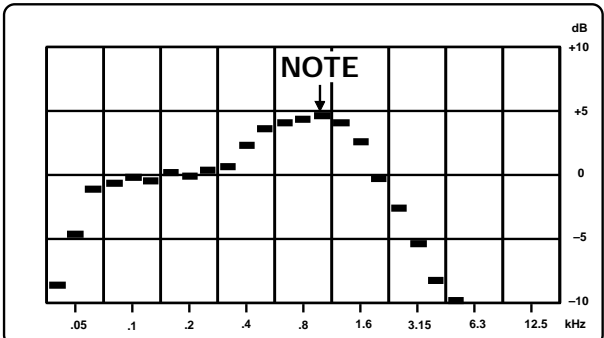
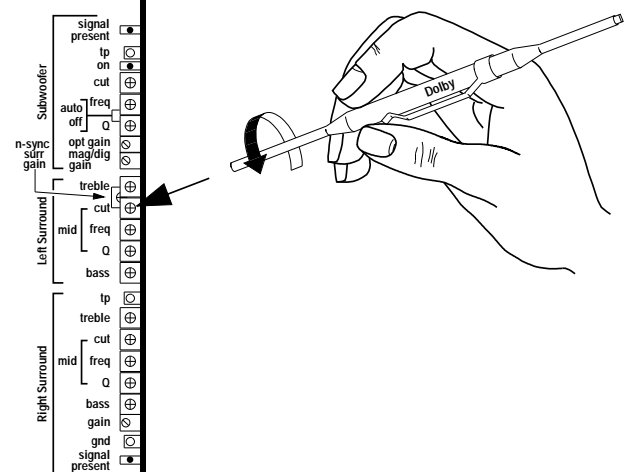
Step No.	Action	Indication
<p>4</p>	<p>Cat. No. 441</p> 	
<p>5</p>	<p>Cat. No. 441</p> 	
<p>6</p>	<p>Cat. No. 441</p> 	

Cat. No. 441—Surround Equalization Alignment**Notes**

Adjust the **Left Surround bass control** on the Cat. No. 441 card for as flat as possible low frequency response on the RTA. Use caution when adjusting the bass control; many surround loudspeaker systems are deficient in their low frequency response. Attempts to boost the output of such system beyond their capabilities simply wastes amplifier power and can result in distortion and possibly damage to the surround loudspeakers.

Adjust the **Left Surround treble control** to its mid point, so that it provides neither cut nor boost.

Adjust the mid frequency controls as follows: Turn the **Cut** control fully clockwise (CW). Set the **Q** and **freq** controls to their mid positions.

Note the position of the center of the highest frequency peak in the 350 Hz to 3 kHz region on the analyzer screen.

Turn the **Cut** control fully counterclockwise and note the position of the notch produced by the equalizer.

Surround EQ Alignment Instructions from the CP65 Manual

Cat. No. 441—Surround Equalization Alignment

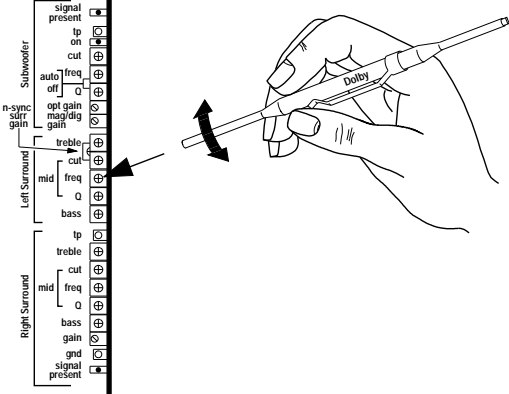
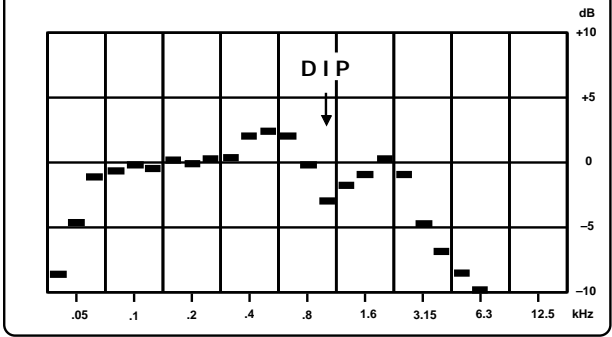
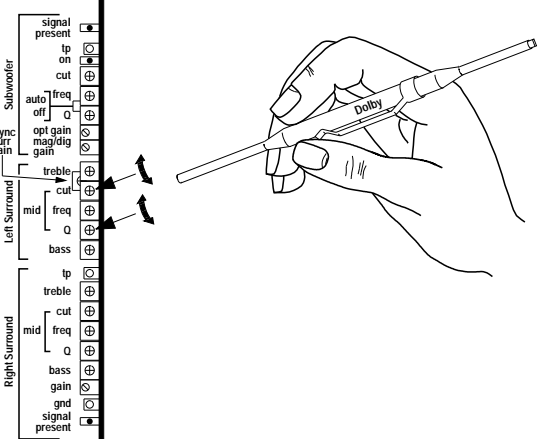
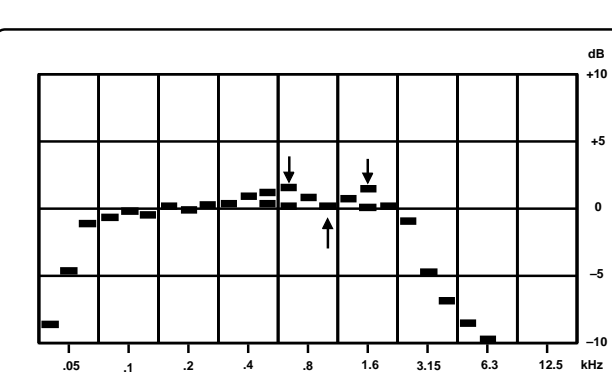
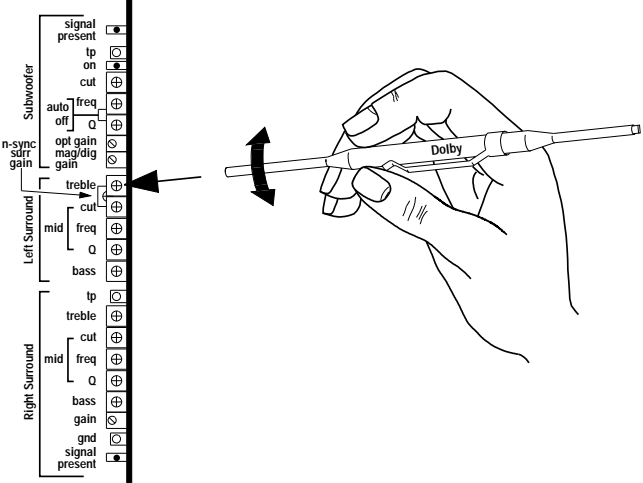
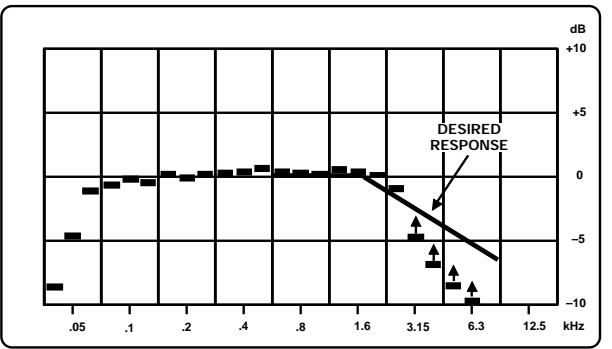
Step No.	Action	Indication
7	<p>Cat. No. 441</p> 	
8	<p>Cat. No. 441</p> 	
9	<p>Cat. No. 441</p> 	
10	<p>REPEAT 7 → 9</p>	

Cat. No. 441—Surround Equalization Alignment**Notes**

Turn the **freq** control so that the notch is located over the peak noted in the previous step.

Adjust the **Cut** and **Q** controls for the flattest response in this part of the spectrum.

Adjust the **treble** control on the Cat. No. 441 card for the best approximation to the desired response shown.

The treble and mid equalizer controls interact. Repeat the adjustments until no further adjustment is required and you have attained the optimum frequency response.

Surround EQ Alignment Instructions from the CP65 Manual

Cat. No. 441—Surround Equalization Alignment

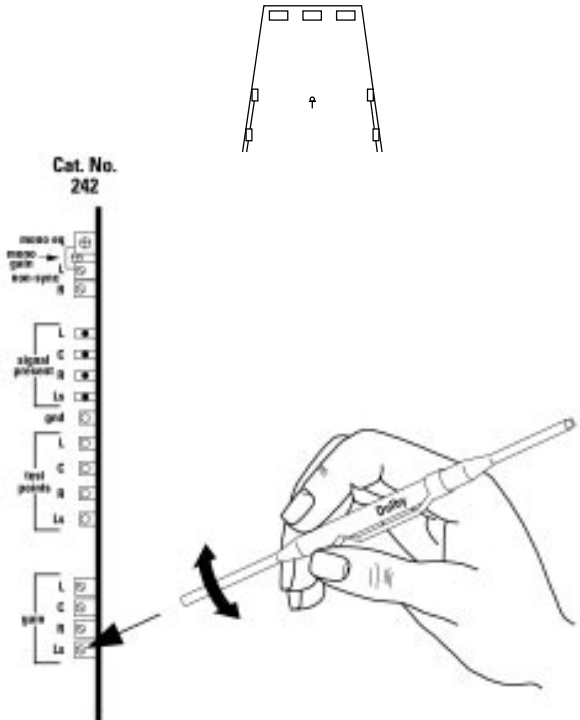
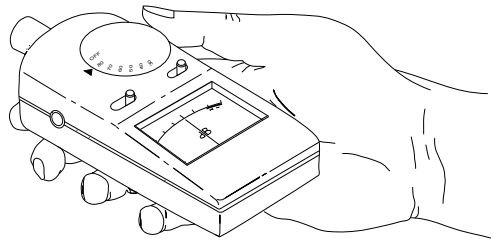
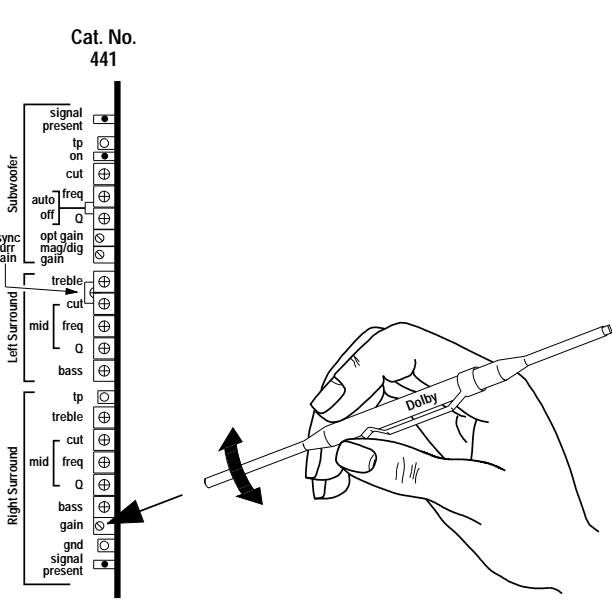
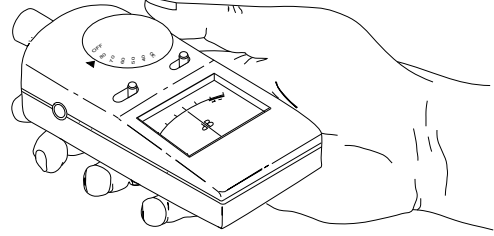
Step No.	Action	Indication
<p>11</p>	 <p>Cat. No. 242</p> <p>mono</p> <p>mono gain</p> <p>mono sync</p> <p>L</p> <p>align</p> <p>phase</p> <p>L</p> <p>gain</p> <p>L</p> <p>test</p> <p>present</p> <p>L</p> <p>gain</p> <p>L</p> <p>gain</p> <p>L</p> <p>gain</p>	<p>MONO SURROUND STEREO SURROUND</p> <p>88 dBC 85 dBC</p> 
<p>12</p>	<p>RIGHT SURROUND AMP</p> <p>ON</p> <p>LEFT SURROUND AMP</p> <p>OFF</p>	
<p>13</p>	 <p>Cat. No. 441</p> <p>signal present</p> <p>tp</p> <p>on</p> <p>cut</p> <p>Subwoofer</p> <p>auto</p> <p>freq</p> <p>off</p> <p>opt gain</p> <p>mag/dig</p> <p>gain</p> <p>treble</p> <p>cut</p> <p>Left Surround</p> <p>mid</p> <p>freq</p> <p>Q</p> <p>bass</p> <p>tp</p> <p>treble</p> <p>cut</p> <p>Right Surround</p> <p>mid</p> <p>freq</p> <p>Q</p> <p>bass</p> <p>gain</p> <p>gnd</p> <p>signal present</p>	<p>85 dBC</p> 
<p>14</p>	<p>REPEAT 4 → 11</p>	

Cat. No. 441—Surround Equalization Alignment**Notes**

Adjust the **Ls** (Left surround) gain control on the Cat. No. 242 B-Chain card for a sound pressure level of 85 dBC (or 88 dBC if only one surround output is to be used).





If the surround speakers are wired for stereo operation or both surround outputs are in use, switch **on** (or reconnect the input to) the **right surround** amplifier or amplifiers. Switch off (or disconnect the input to) the Left surround amplifier or amplifiers.

With the microphone still located at the center of the theatre, adjust the **Right Surround gain** control on the Cat. No. 441 surround and subwoofer card for a sound pressure level of 85 dBC.

Repeat Steps 4 through 11 using the **Right Surround** pots on the Cat. No. 441 card.
NOTE: When you reach Step 11 remember that the right surround gain control is located on the Cat. No. 441 board.

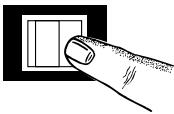
Surround EQ Alignment Instructions from the CP65 Manual

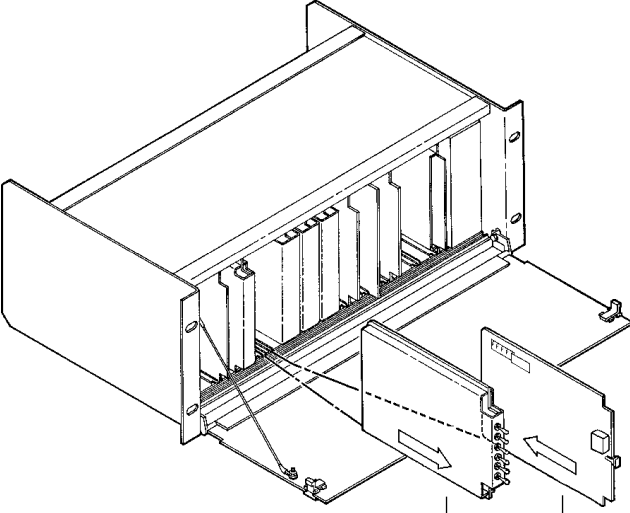
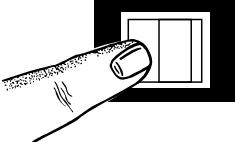
Cat. No. 441—Surround Equalization Alignment

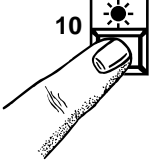
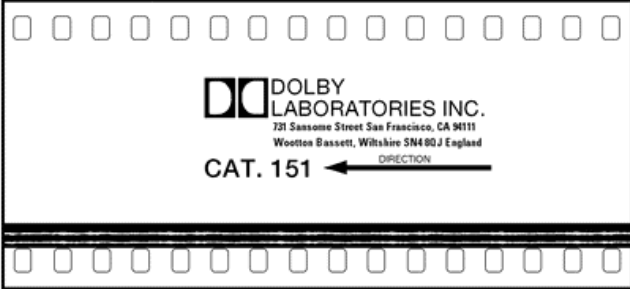
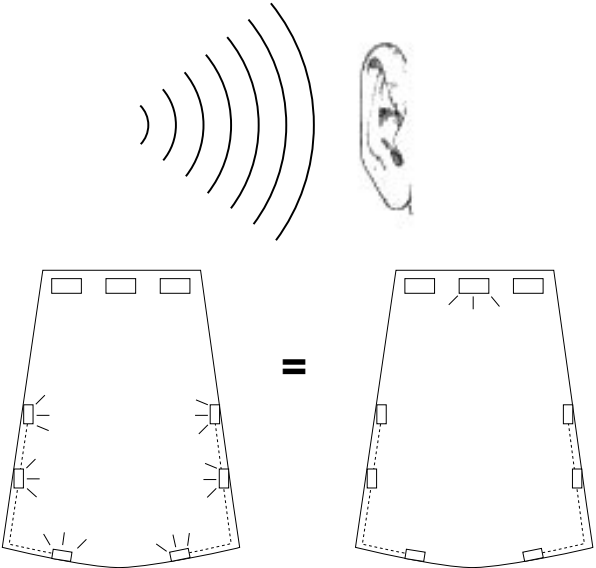
Step No.	Action	Indication
15	<p>NORMAL BYPASS</p> 	<p>bypass  (switch behind panel)</p>
16	 <p>Cat. No. 85 Cat. No. 150</p>	
17	<p>NORMAL BYPASS</p>  <p>10  Dolby Stereo Digital</p> 	
18	 <p>DOLBY LABORATORIES INC. 321 Sansome Street San Francisco, CA 94111 Wootton Bassett, Wiltshire SN4 6QJ England CAT. 151 ← DIRECTION</p>	

Cat. No. 441—Surround Equalization Alignment**Notes**

Open the CP65 and place the **NORMAL/BYPASS** switch in the **BYPASS** position.

Remove the Cat. No. 85C card and re-install the Cat. No. 150 card.

Restore the **BYPASS/NORMAL** switch to the **NORMAL** position.

Confirm that format **04 Dolby Stereo A-Type** is selected.

Thread and play the Cat. No. 151 stereo optical surround level film. Check the sound by walking around the theatre. The surround and center channels should sound equally loud at most locations and left and right surround channels should sound equally loud and have similar frequency response in the center of the theatre. If necessary, readjust the left and right surround gains until you are satisfied with the surround-to-front center balance. A large change in the gain setting should be unnecessary.

2.5.3.3 Installation of Cat. Nos. 517, 137L, and 560 in a CP200 WITH an accessory unit fitted with Cat. No. 64 Equalizers for P (Left Surround) and Q (Right Surround) Channels

Install the wiring shown in the wiring pictorial diagram (**Figure 2.15**). Note that the surround equalization sections of the Cat. No.560 are not used.

Description of backplane wiring (with accessory unit and EQ for P, Q channels)

FROM	TO	FUNCTION	FIGURE REF.
SK30 pin A (Cat. No. 517)	SK28 pin A (Cat. No. 517)	optical surround trim VCA signal	A
SK30 pin M	SK28 pin M (Cat. No. 517)	Dolby Digital valid logic signal from DA20 (low = valid)	B
SK28 pin M	SK13 pin B21 (Cat. No. 560)	Dolby Digital valid logic signal from DA20 (low = valid)	C
SK 28 pin S	SK28 pin 7 (Cat. No. 517)	Grounds pin S to indicate card is in left slot, disabling C/S channel treble compensation and enabling surround trim pot to control P (Left surround) and Q (Right surround) channels.	D

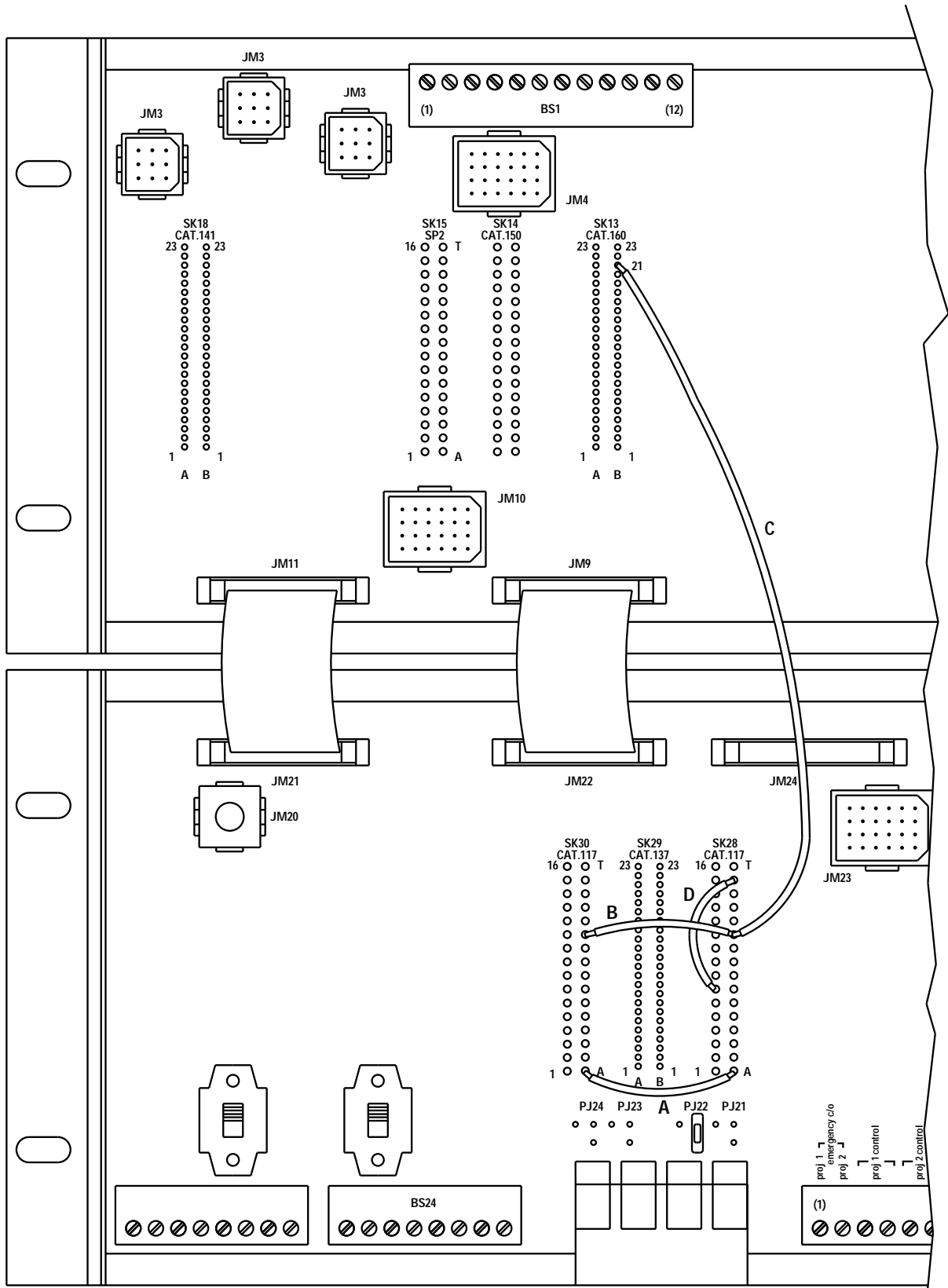

Figure 2.15 CP200 Wiring with accessory unit and EQ for P, Q Channels

When the backplane wiring is done as shown in the figure, the operation of the Cat. No.517s for the S, P (left surround), and Q (right surround) channels is as follows:

The optical surround trim (the upper pot on the left-hand Cat. No.517) now functions as a surround trim governing all three surround outputs at once when an analog optical format with surround (formats 04 or 05) is selected. A range of ± 10 dB around the nominal setting is provided. In all other formats, this pot is disabled.

If Cat. No. 64 EQ cards are being installed in the accessory unit for the first time, the surrounds must be equalized. Refer to the CP200 Installation Manual, page 47.

2.5.3.4 Equalization of the Subwoofer Channel

Refer to the Cat. No.441 alignment instructions on the following pages (from the CP65 Manual).

Remove the Cat. No.141 from slot 23 (fourth slot in from the left), insert the Cat. No.85 in its place. If Le and Re speakers are also installed, remove the Cat. No.141 from slot 35 (third slot in from the right). Select **format 42** (Dolby Stereo 70 mm). Select **Le** on the Cat. No.85 to send pink noise to the subwoofer. Use a calibrated microphone and a RTA to EQ the subwoofer channel according to the instructions. After completing this step, reinstall the two Cat. No.141s into slots 23 and 35.

No text on this page.

Cat. No. 441—Subwoofer Alignment from the CP65 Manual

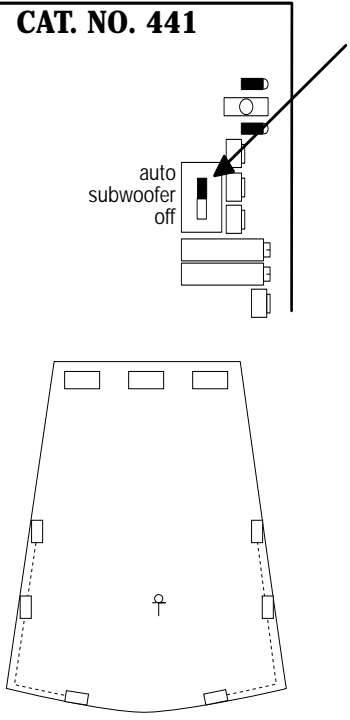
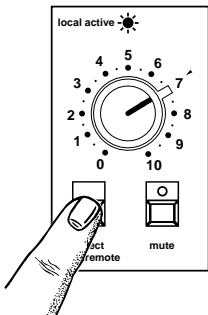
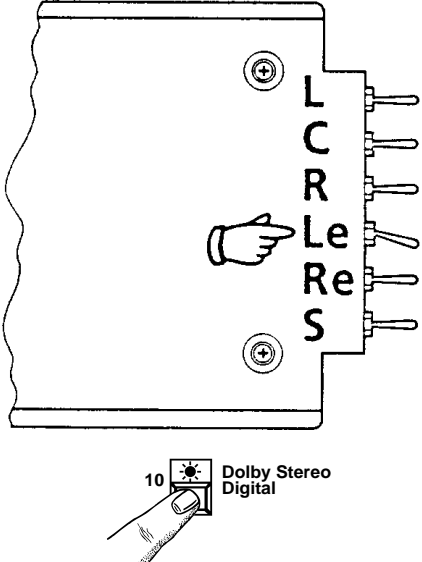
Step No.	Action	Indication
<p>1</p>	<p>CAT. NO. 441</p> 	
<p>2</p>		
<p>3</p>		

Cat. No. 441—Subwoofer Alignment from the CP65 Manual**Notes**

The **Subwoofer auto/off** switch on the Cat. No. 441 card enables the subwoofer in formats other than Non-sync (format 60) , Mono (format 01) and magnetic no NR (format 22). The switch must be in the **auto (up)** position at any time the subwoofer system is to function.

Confirm that the microphone is in the position shown.

All connections established in the room equalization procedure apply to the following steps.

The main front panel **FADER** should be active and set to **7**. If necessary, press the **select local/remote** switch.

Place the Le toggle switch on the Cat. No. 85C card in the ON (up or down) position and set the CP65 to format **10 Dolby Digital**.

Cat. No. 441—Subwoofer Alignment from the CP65 Manual

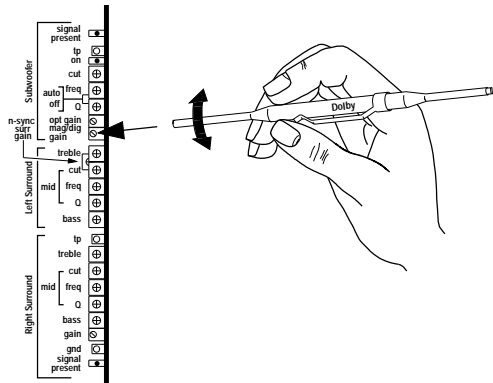
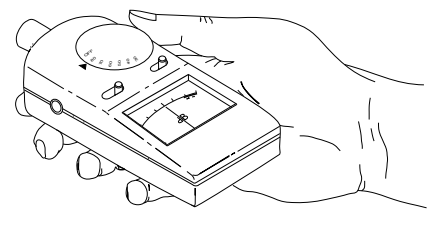
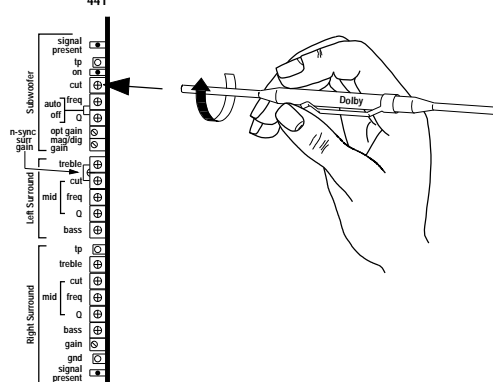
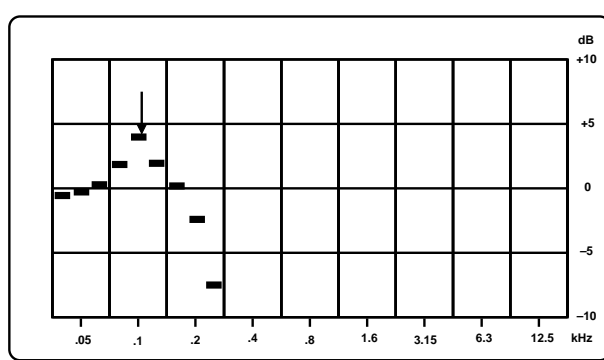
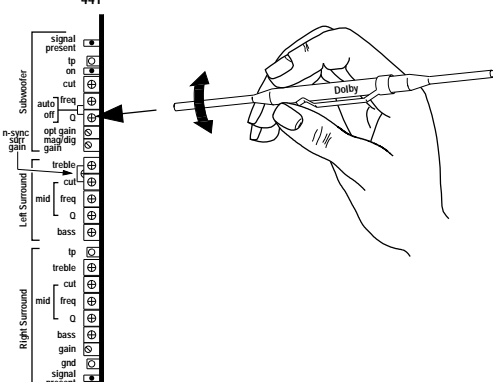
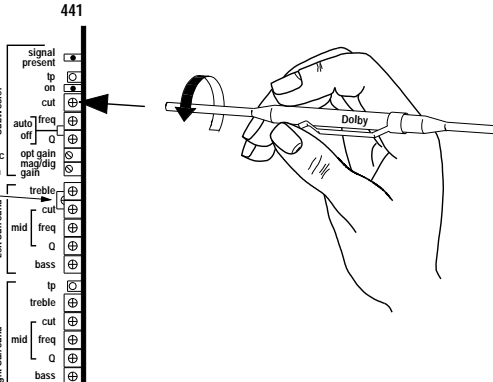
Step No.	Action	Indication
<p>4</p>	<p>Cat. No. 441</p> 	<p>90 dBC → 85 dBC</p> 
<p>5</p>	<p>Cat. No. 441</p> 	
<p>6</p>	<p>Cat. No. 441</p> 	
<p>7</p>	<p>Cat. No. 441</p> 	

Cat. No. 441—Subwoofer Alignment from the CP65 Manual

Notes

Adjust the **mag/dig gain** control on the Cat. No. 441 card for a 90 dBC SPL (sound pressure level) in the theatre. (If this level cannot be obtained it may be necessary to change the **J2** jumper setting to increase or decrease the output.) When you have obtained this level turn the **mag/dig gain** control **down** for an 85 dBC SPL.

Note

This level is only an approximation. Sound pressure level meters are not appropriate for setting accurate levels of narrow band signals. The correct final level will be set later in this procedure using an RTA.

Turn the **cut** control at the top of the Cat. No. 441 card to the fully clockwise (CW) position for minimum cut. This disables the subwoofer equalizer circuit.

Note the frequency of the peak in the response. You will need this information in Step 9 following.

Turn the **Q** control on the Cat. No. 441 card to its mid point (for a moderately wide notch).

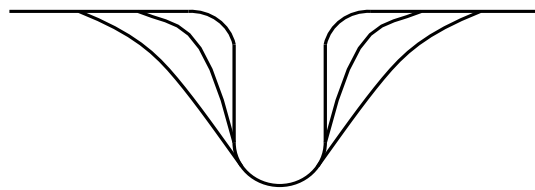

Turn the **cut** control back to the fully counterclockwise (CCW) position for full cut.

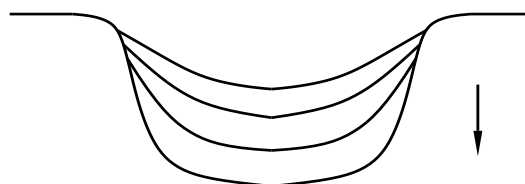

Cat. No. 441—Subwoofer Alignment from the CP65 Manual

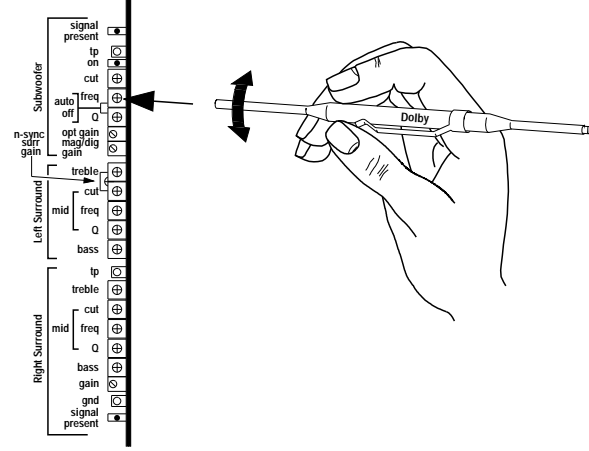
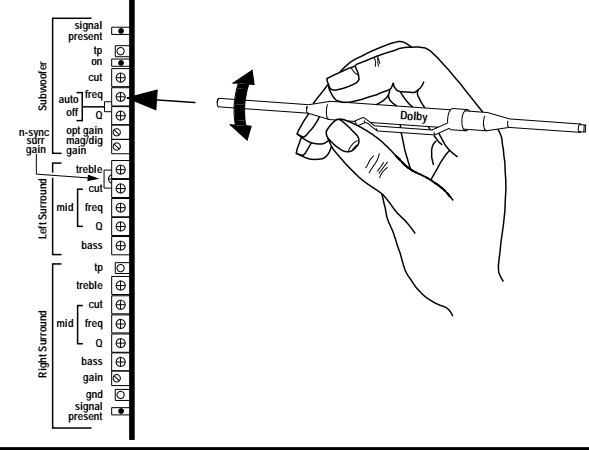
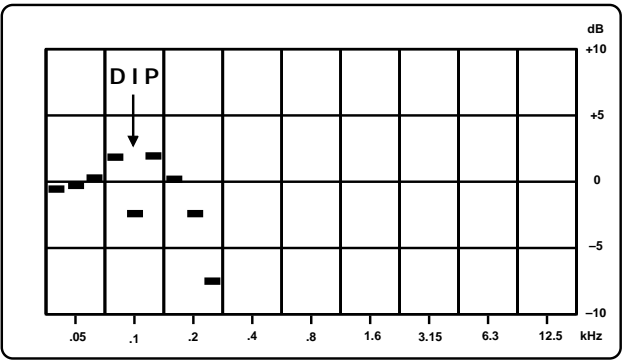
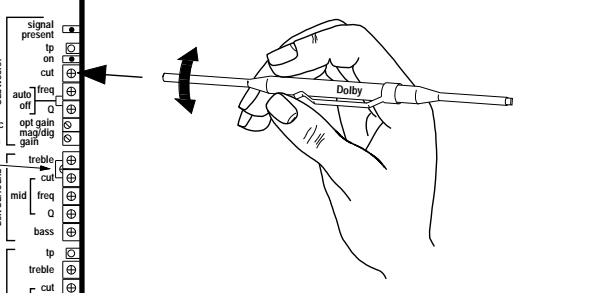
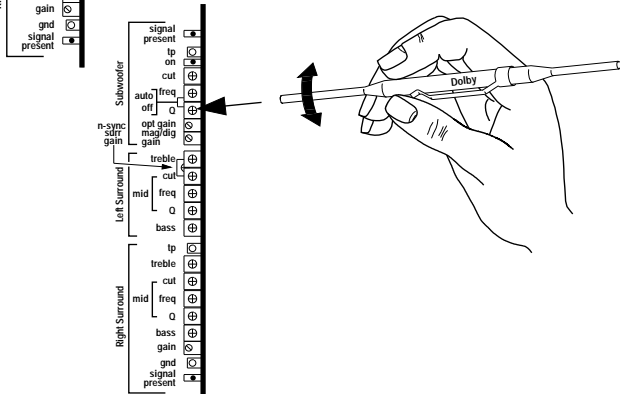
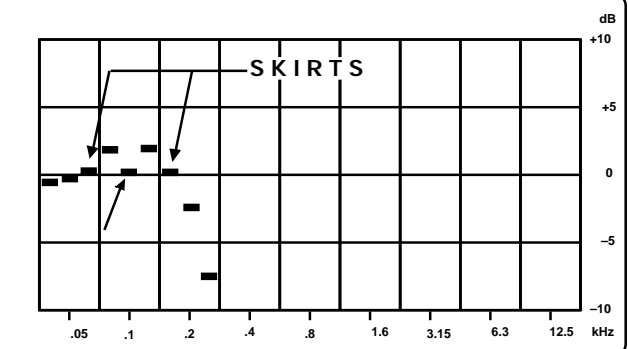
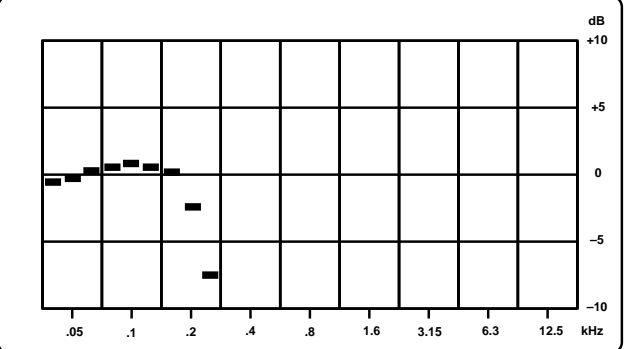
Step No.	Action	Indication
<p>8</p>	<p>Cat. No. 441</p> 	
<p>9</p>	<p>Cat. No. 441</p> 	 <p>The graph plots dB (y-axis, -10 to +10) against kHz (x-axis, logarithmic scale: .05, .1, .2, .4, .8, 1.6, 3.15, 6.3, 12.5). A downward spike labeled 'DIP' is visible at approximately 0.1 kHz.</p>
<p>10</p>	<p>Cat. No. 441</p>  <p>Cat. No. 441</p> 	 <p>The graph plots dB (y-axis, -10 to +10) against kHz (x-axis, logarithmic scale: .05, .1, .2, .4, .8, 1.6, 3.15, 6.3, 12.5). A flat-topped peak labeled 'SKIRTS' is visible at approximately 0.1 kHz.</p>  <p>The graph plots dB (y-axis, -10 to +10) against kHz (x-axis, logarithmic scale: .05, .1, .2, .4, .8, 1.6, 3.15, 6.3, 12.5). The response curve is relatively flat across the frequency range.</p>

Cat. No. 441—Subwoofer Alignment from the CP65 Manual

Notes

Turn the **freq** control on the Cat. No. 441 card. A dip in the frequency response will move along the frequency axis of the RTA display.

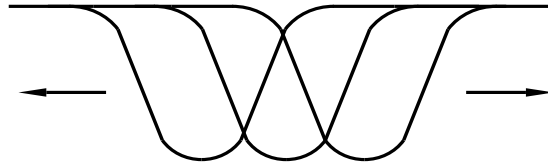

Adjust the **freq** control so the center of the dip is in the same band as the highest peak in the unequalized subwoofer frequency response you were asked to take note of in Step 5.

FROM **5**:

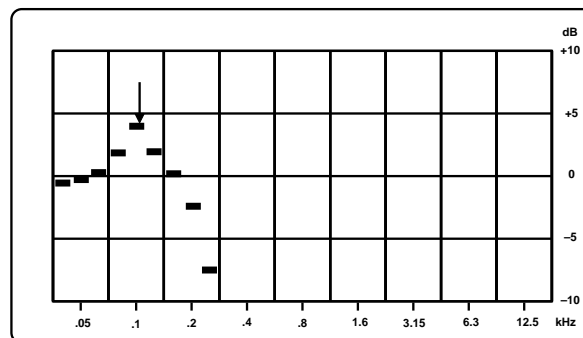

Adjust the **cut** control so the center of the dip flattens. The center of the dip should be at the same level as the skirts.

Adjust the **Q** control for the flattest possible frequency response.

Cat. No. 441—Subwoofer Alignment from the CP65 Manual

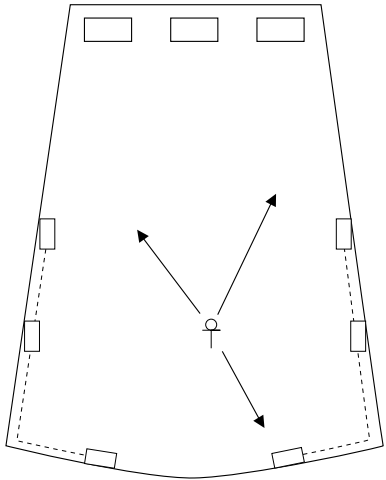
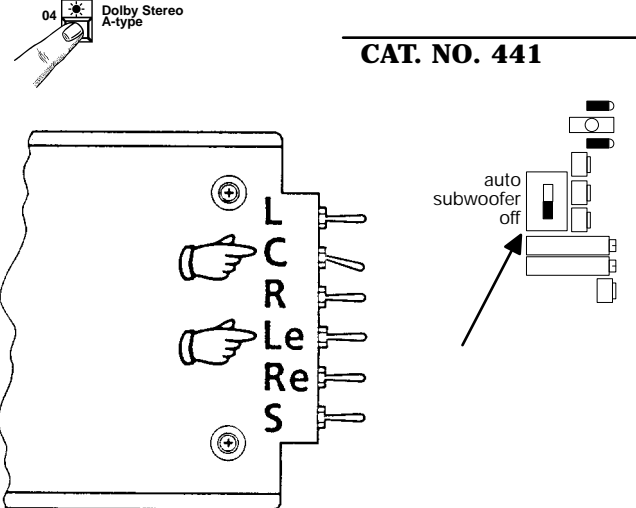
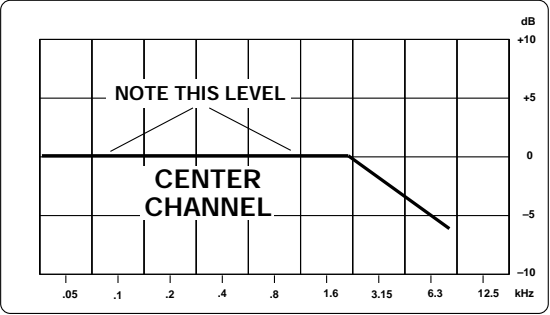
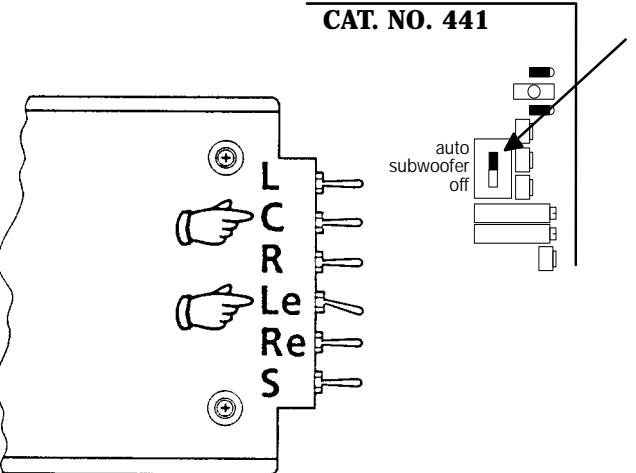
Step No.	Action	Indication
<p>11</p>	 <p>REPEAT 8 → 10</p>	
<p>12</p>	 <p>04 Dolby Stereo A-type</p> <p>CAT. NO. 441</p>	 <p>dB</p> <p>+10</p> <p>+5</p> <p>0</p> <p>-5</p> <p>-10</p> <p>NOTE THIS LEVEL</p> <p>CENTER CHANNEL</p> <p>.05 .1 .2 .4 .8 1.6 3.15 6.3 12.5 kHz</p>
<p>13</p>	 <p>CAT. NO. 441</p>	

Cat. No. 441—Subwoofer Alignment from the CP65 Manual**Notes**

If using a single microphone, relocate the microphone to at least one other location in the theatre and check the audio spectrum on the RTA. Repeat the freq, cut, and Q adjustments to obtain a good average overall equalization at these locations of the microphone.

Select format **04 Dolby Stereo A-Type**.

Place the **Le** toggle switch on the Cat. No. 85C card in the **OFF** (center) position and place the **C** (center channel) toggle switch in the **ON** position.

Place the subwoofer switch on the Cat. No. 441 in the **OFF** position.

Note the average level of the third-octave bands between 100 Hz and 1 kHz.

Place the **C** toggle switch in the **OFF** (center) position and place the **Le** toggle switch in the **ON** (up or down) position.

Place the subwoofer switch on the Cat. No. 441 in the **auto** position.

Cat. No. 441—Subwoofer Alignment from the CP65 Manual

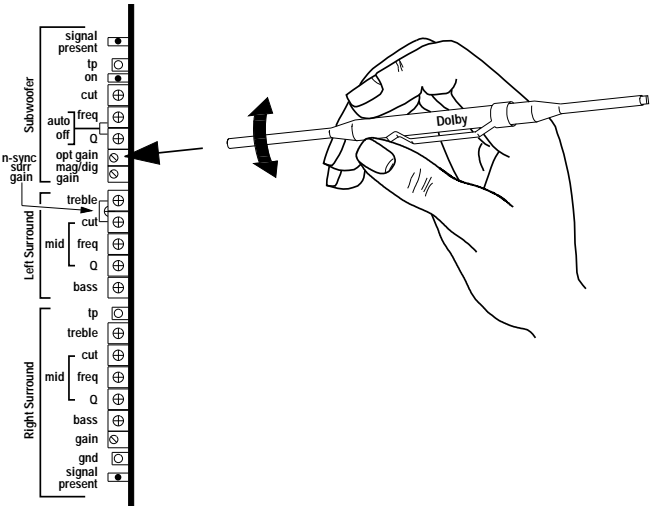
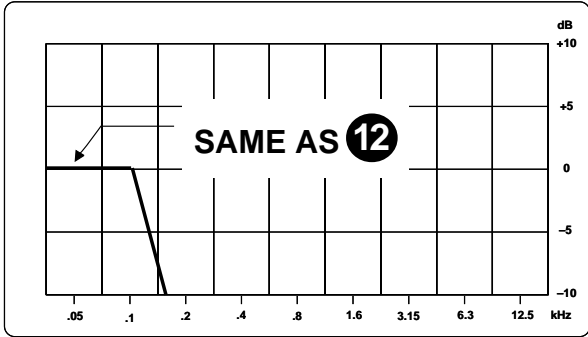
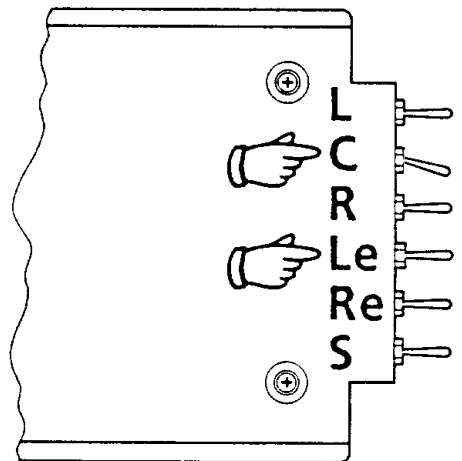
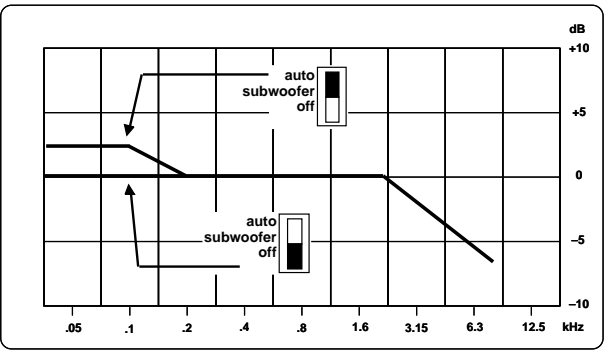
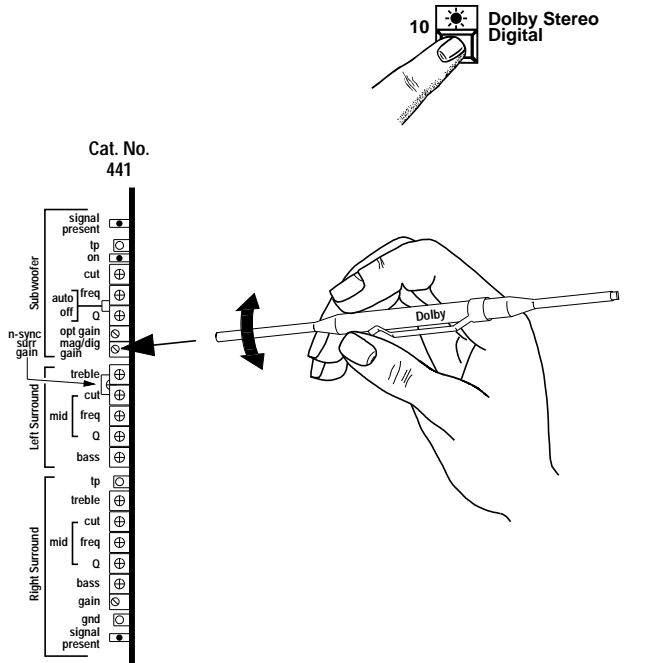
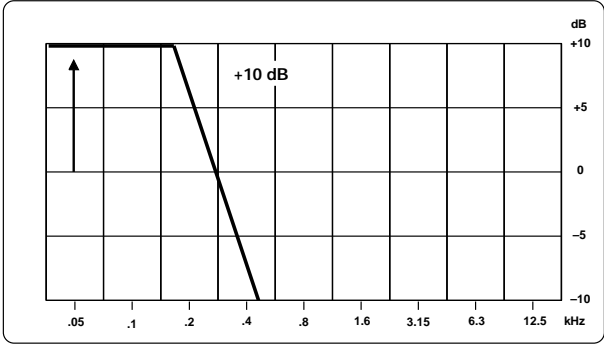
Step No.	Action	Indication
<p>14</p>	<p>Cat. No. 441</p> 	
<p>15</p>		
<p>16</p>		

Cat. No. 441—Subwoofer Alignment from the CP65 Manual**Notes**

Adjust the **optical gain** control on the Cat. No. 441 card so that the average level of the bands from the subwoofer is at the same level on the analyzer screen as you noted for the center channel in the previous step.

Place the **Le** toggle switch on the Cat. No. 85C card in the **OFF** (center) position and place the **C** (center channel) toggle switch in the **ON** position.

Note the change in the average level of the bands from 20 Hz to 100 Hz when the subwoofer switch on the Cat. No. 441 is switched between **OFF** and **AUTO**. There should be a level **INCREASE** when it is switched to **AUTO**. The subwoofer is out of phase with the front channels if you do not see this level increase. Reverse the subwoofer(s) speaker connections.

Re-select Format 10.

Adjust the **mag/dig gain** on the Cat. No. 441 so that the level of the bands from the subwoofer increases 10 dB above the level in the previous step.

The subwoofer alignment is completed.

2.5.3.5 Output level adjustments of Cat. Nos. 517 and 560 in CP200

1. Adjustment of P and Q channels.

Select **format 40** (70 mm mag no NR). Note: If only the S (mono surround output) is used proceed to step 2.

Remove the Cat. No.141 from slot 37 of the CP200 processor unit (first slot in from the right), insert the Cat. No.85 pink noise generator in its place. Be sure to mute the processor when removing or inserting a card. The **Center** switch on the Cat. No.85 will send pink noise to P (left surround) and the **Surround** switch will send it to Q (right surround). Using a SPL meter set to dBC slow, adjust the P and Q controls on the Cat. No.517 to obtain 82 dBC on each channel. Switch on pink noise to both P and Q together and verify that 85 dBC SPL is reached. After completing this step, reinstall the Cat. No.141 into slot 37.

2. Adjustment of Left, Center, Right and Le, Re channels.

Remove the Cat. No.141 from slot 35 (third slot in from the right), insert the Cat. No.85 in its place. Adjust the left, center, right and if installed, left extra and right extra channels to 85 dBC. Select **format 01** (optical mono). Select **Center** on the Cat. No.85 and adjust the mono level control on the right Cat. No.517 to obtain 79dBC.

3. Adjustment of optical surround and mono surround.

Reselect **format 40**, select **Surround** on the Cat. No.85. If the mono surround (S) output is used set the **Mag S** level control on the left Cat. No.517 to 85 dBC. Select **format 04** (Dolby Stereo optical) and adjust the **Opt S** surround level control to read 88 dBC on the SPL meter. Note: This control trims the level of all three surround outputs (P, Q and S) previously set and therefore will affect whichever set of outputs (P and Q or S) is used. After completing this step, reinstall the Cat. No.141 into slot 35.

Thread up and play a loop of Cat. No.151B surround level test film. While in the most commonly used seating area of the auditorium, listen and check that the level of the surrounds is subjectively the same as the front channels. If needed, readjust the **Opt surround** level control on the left hand Cat. No.517 to obtain the correct balance.

4. Adjustment of optical subwoofer level.

Remove the Cat. No.141 from slot 23 (fourth slot in from the left), insert the Cat. No.85 in its place. Shut off **S1** (subwoofer enable) on the Cat. No.560 to mute the subwoofer output. Select **Left** and **Right** on the Cat. No.85; the pink noise will be decoded to the center channel speaker. Using a RTA, observe the level of the pink noise from the center channel, note the amplitude on the display. Turn on **S1** on the Cat. No.560. Remove the Cat. No.141 switch card from slot 35 (third slot in from the right) to disable the other stage speakers. While observing the RTA, adjust the **Opt** subwoofer level control on the Cat. No.560 so that the subwoofer in-band level is the same as the center channel midrange level previously observed. After completing this step, reinstall the Cat. No.141 into slot 35.

5. Adjustment of magnetic/digital subwoofer level.

a. Systems with subwoofers but no Le or Re speakers.

Select **format 42** (Dolby Stereo 70 mm). Select **Center** on the Cat. No.85, using a RTA observe the level of the pink noise from the center channel, note the amplitude on the display. Note: This is not the same level as observed in step 4. Shut off **Center** on the Cat. No.85 and select **Le**. While observing the RTA, adjust the **Mag/Dig** subwoofer level control on the Cat. No.560 so that the subwoofer inband level is 10 dB higher than the center channel midrange level previously observed. After completing this step, proceed to step 6.

b. Systems with subwoofers and Le Re speakers.

Select **format 42** (Dolby Stereo 70 mm). Select **Center** on the Cat. No.85, using a RTA observe the level of the pink noise from the center channel, note the amplitude on the display. Note: This is not the same level as observed in step 4. Shut off **S1** (subwoofer enable) on the Cat. No.560 to mute the subwoofer output. Shut off **Center** on the Cat. No.85 and select **Le**. While observing the RTA, adjust the **Mag** level control on the Cat. No.142 so that the Le inband level is 10 dB higher than the midrange level of the center channel that was previously observed. Turn on **S1** on the Cat. No.560 card. Remove the Cat. No.141 switch card from slot 35 (third slot in from the right) to disable the other stage speakers. While observing the RTA, adjust the **Mag/Dig** subwoofer level control on the Cat. No.560 so that the subwoofer inband level is 10 dB higher than the center channel midrange level that was previously observed. **Note:** The Le and Re speakers are only used in mag formats with the Cat. No.560 and the **Opt** control on the Cat. No.142 is not used.

6. Remove the Cat. No.85 and reinstall all Cat. No.141 cards. The B-chain adjustments of the new cards are completed.

2.5.3.6 DA20 to CP200 Wiring Tables

Refer to the DA20 to CP200 wiring diagram fold-out, Figure 2.11.

Audio from DA20 to CP200		Audio from CP200 to DA20	
DA20 CP Audio Conn. J8 (DB25 Male) Pin no.	CP200 JM21 (IDC 20 pin) Pin no.	DA20 CP Audio Conn. J7 DB25 Female Pin no.	CP200 JM11 (IDC 20 pin) Pin no.
1 AGND	1 GND	1 AGND	1 GND
2 Rs out	2 Q	2 Rs in	2 Q
3 AGND	3 blank	3 AGND	3 blank
4 AGND	4 blank	4 AGND	4 blank
5 AGND	5 blank	5 AGND	5 blank
6 AGND	6 blank	6 AGND	6 blank
7 AGND	7 blank	7 AGND	7 blank
8 AGND	8 blank	8 AGND	8 blank
9 AGND	9 blank	9 AGND	9 blank
10 AGND	10 blank	10 AGND	10 blank
11 AGND	not connected	11 AGND	not connected, cut short
12 AGND	not connected, cut short	12 AGND	not connected, cut short
13 AGND	not connected, cut short	13 AGND	not connected, cut short
14 L out	11 L	14 L in	11 L
15 Ls out	12 P	15 Ls in	12 P
16 Re out	13 Re	16 Re in	13 Re
17 R out	14 R	17 R in	14 R
18 Le out	15 Le	18 Le in	15 Le
19 n.c.	16 blank	19 n.c.	16 blank
20 C out	17 C	20 C in	17 C
21 S out	18 S	21 n.c.	18 S
22 n.c.	19 blank	22 n.c.	19 blank
23 n.c.	20 blank	23 n.c.	20 blank
24 SW out	not connected to JM21, but soldered to pin B1 of SK13	24 n.c.	not connected, cut short
25 Spare out	not connected, cut short	25 Spare in	not connected, cut short

CP200 to DA20 Sense/Control

The DA20 monitors the CP200 Future 8 and Future 11 control lines to determine which format is selected on the CP200. A low level on Future 8 indicates that format 10 is selected. A low level on Future 11 indicates that an optical film format is selected. Future 11 is used to cause the DA20 to assert format 10 automatically when the DA20 is in Auto Digital Mode and valid digital audio is present. See the DA20 Users' Manual for specific information on the Auto Digital feature.

CTRL0 through CTRL7 are used to control and read status from the CP200 via the Cat. No. 493 Auto Digital Adapter board. The DA20 is connected directly to the Cat. No. 493 adapter board using a 25 pin shielded cable. If no Cat. No. 493 is available, the DA20 and CP200 can operate in non-auto digital mode by connecting the DA20 directly to the CP200 backplane. The signals required for basic operation of the DA20 and CP200 are listed in the table below in **bold** type:

DA20 J6 DB25 Male Pin Number	Cat. No. 493 DB25 Female Pin Number / CP200 Backplane
1 CTRL0	1 SW Control / B21 of SK13 (Soldered)
2 CTRL1	2 Assert GO Button
3 CTRL2	3 Format A Assert
4 CTRL3	4 Format B Assert
5 CTRL4	5 Format C Assert
6 CTRL5	6 Format D Assert
7 CTRL6	7 GO Button Monitor
8 CTRL7	8 Future 11 / A19 of SK27 (Soldered)
9 N.C.	9 N.C.
10 N.C.	10 N.C.
11 N.C.	11 N.C.
12 GND	12 GND / BS23 Pin 5
13 N.C.	13 N.C.
14 Sense0	14 Future 8 / Pin 14 of SK15 (Soldered)
15 N.C.	15 N.C.
16 N.C.	16 N.C.
17 N.C.	17 N.C.
18 N.C.	18 N.C.
19 N.C.	19 N.C.
20 N.C.	20 N.C.
21 N.C.	21 N.C.
22 N.C.	22 N.C.
23 N.C.	23 N.C.
24 N.C.	24 N.C.
25 C/O Status	25 Projector 2 / BS23 Pin 6

(The CTRL0 line held low causes the CP200 to reproduce the digital SW channel from the DA20.)

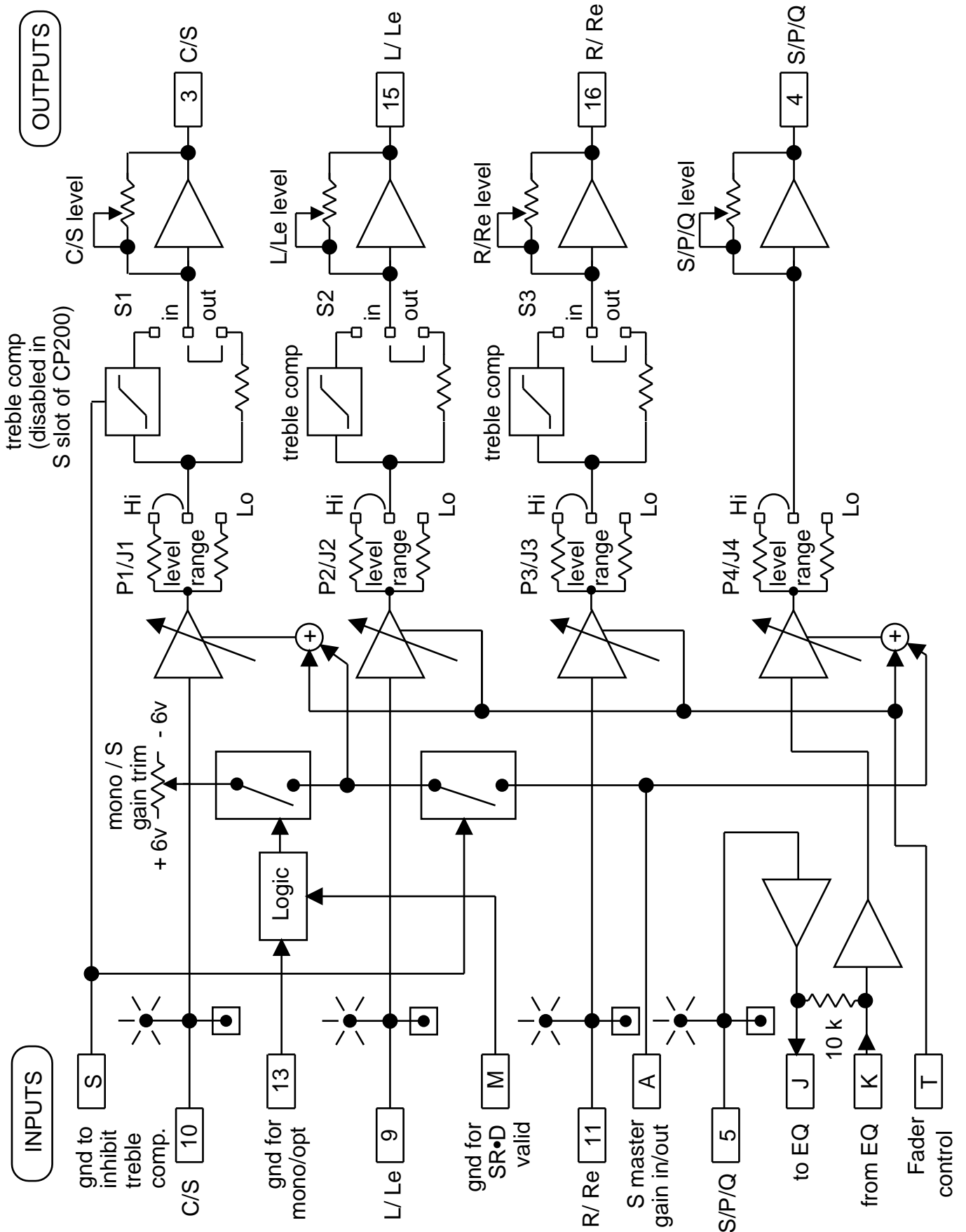

Figure 2.16 Cat. No.517 Block Diagram

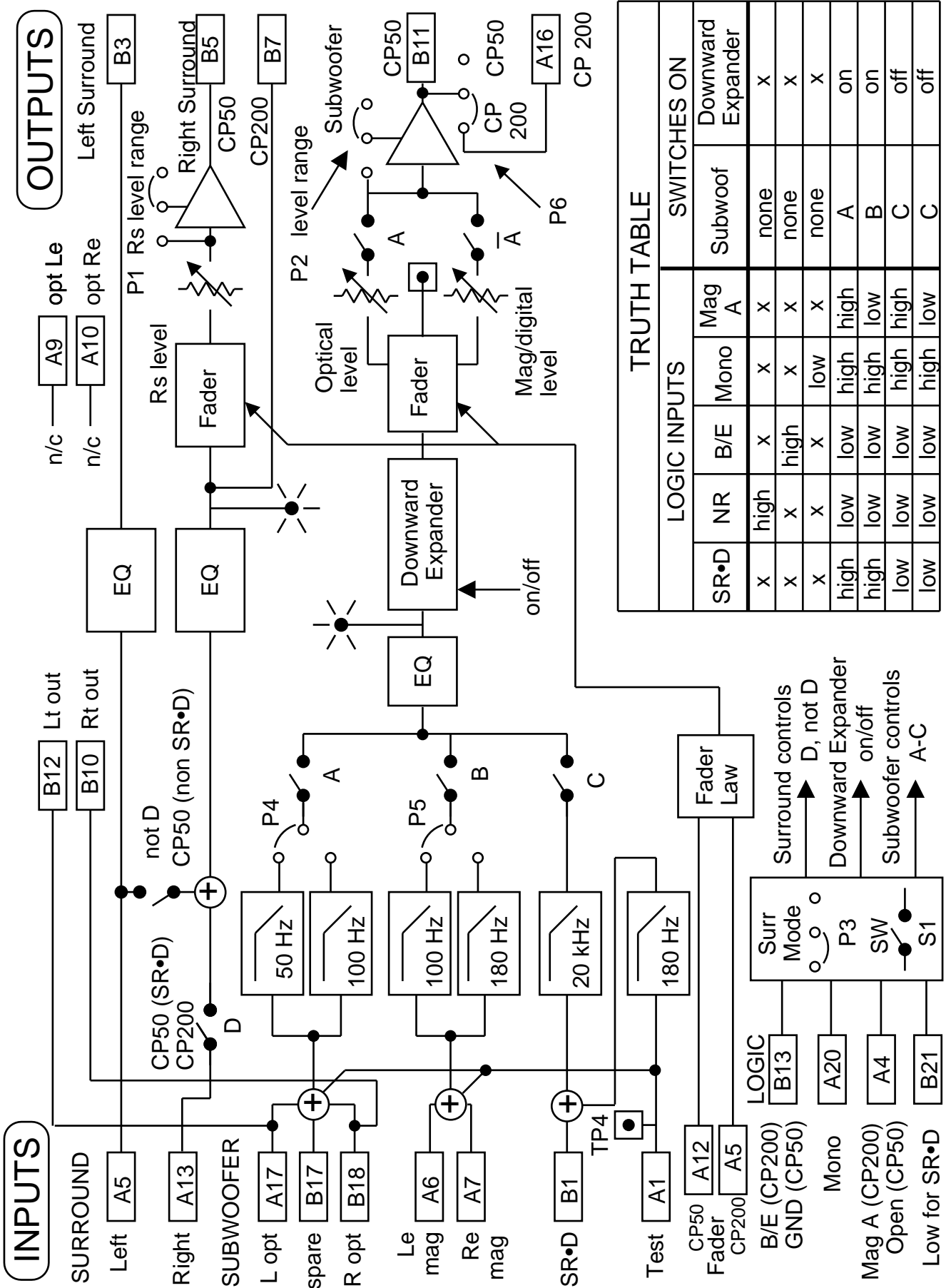

Figure 2.17 Cat. No.560 Block Diagram

2.5.4 Installation of DA20 with CP45

An Adapter board, Cat. No. 545, is available for connecting the DA20 to the CP45 rear panel connector J10. Refer to the CP45 wiring Diagram fold-out, **Figure 2.18**.

Audio from DA20 to CP45

(This cable is Available from Dolby Laboratories as Part No. 83306)

DA20 Audio Out to CP Conn. J8 (DB25 Male) Pin No.	CP45 Non-Sync/Aux Conn. J5 ("Phoenix" Male) Pin No.
1 AGND	4 - Com
2 Rs Out	6 - Rs
3 AGND	N.C.
4 AGND	N.C.
5 AGND	N.C.
6 AGND	N.C.
7 AGND	N.C.
8 AGND	N.C.
9 AGND	N.C.
10 AGND	N.C.
11 AGND	N.C.
12 AGND	N.C.
13 AGND	8 - Com
14 L Out	1 - L
15 Ls Out	5 - Ls
16 Re Out	N.C.
17 R Out	3 - R
18 Le Out	N.C.
19 N.C.	N.C.
20 C Out	2 - C
21 N.C.	N.C.
22 N.C.	N.C.
23 N.C.	N.C.
24 SW Out	7 - SW
25 Spare Out	N.C.

DA20 to CP45 Sense/Control

(This cable is Available from Dolby Laboratories as Part No. 83135)

DA20 CP Sense/Control J6 (DB25 Male) Pinout	CP45 Adapter Board Cat. No. 545 Control Logic J12 (DB15 Male) Pinout
1 CTRL0	7 - (01 - mono optical)
2 CTRL1	5 - (04 - Dolby Stereo)
3 CTRL2	6 - (05 - Dolby SR)
4 CTRL3	N.C.
5 CTRL4	10 - (10 - Dolby Digital)
6 CTRL5	N.C.
7 CTRL6	9 - (60 - Non-Sync)
8 CTRL7	N.C.
9 N.C.	N.C.
10 N.C.	N.C.
11 N.C.	N.C.
12 GND	4 - GND
13 N.C.	N.C.
14 Sense 0	N.C.
15 N.C.	N.C.
16 N.C.	N.C.
17 N.C.	N.C.
18 N.C.	N.C.
19 N.C.	N.C.
20 N.C.	N.C.
21 N.C.	N.C.
22 N.C.	N.C.
23 N.C.	N.C.
24 N.C.	N.C.
25 C/O Status	15 - Projector C/O

Format sense and control are accomplished via connection of the CP500 automation lines connected to DA20 CTRL0 through CTRL7. The DA20 monitors the CTRL lines to detect when various formats are selected and asserts Format 10 depending on which mode the DA20 is in. In all cases, the control lines must be low for a minimum of 80ms to be recognized as valid format assertions. The DA20 will assert various control lines depending on which mode is selected on the DA20. See the DA20 Users' Manual for specific information related to the DA20 modes of operation and the Auto Digital feature.

The DA20 switches to Format 05 by holding CTRL2 low for approximately 150ms and returns to Format 10 by asserting CTRL4 low for approximately 150ms.

2.5.5 Installation of DA20 with CP500

Refer to the CP500 wiring Diagram fold-out, **Figure 2.19**

CP500 to DA20 Connection Tables

Audio from DA20 to CP500

DA20 CP Audio Out Conn. J8 (DB25 Male) Pin No.	CP500 6 Channel Input Conn (DB25) Pin No.
1 AGND	1 Signal Ground
2 Rs Out	2 Right Surround Channel Input
3 AGND	3 Signal Ground
4 AGND	4 Signal Ground
5 AGND	5 Signal Ground
6 AGND	6 Signal Ground
7 AGND	7 Signal Ground
8 AGND	8 Signal Ground
9 AGND	9 Signal Ground
10 AGND	10 Signal Ground
11 AGND	11 Signal Ground
12 AGND	12 Signal Ground
13 AGND	13 Signal Ground
14 L Out	14 Left Channel Input
15 Ls Out	15 Left Surround Channel Input
16 Re Out	16 N.C.
17 R Out	17 Right Channel Input
18 Le Out	18 N.C.
19 N.C.	19 N.C.
20 C Out	20 Center Channel Input
21 N.C.	21 N.C.
22 N.C.	22 N.C.
23 N.C.	23 N.C.
24 SW Out	24 Sub Woofer Channel Input
25 Spare Out	25 N.C.

DA20 to CP500 Sense/Control

DA20 CP Sense/Control J6 (DB25 Male) Pinout	CP500 Automation (DB25 Female) Pinout
1 CTRL0	1 SK1 Format Select Input
2 CTRL1	2 SK2 Format Select Input
3 CTRL2	3 SK3 Format Select Input
4 CTRL3	4 SK4 Format Select Input
5 CTRL4	5 SK5 Format Select Input
6 CTRL5	6 SK6 Format Select Input
7 CTRL6	7 SK7 Format Select Input
8 CTRL7	8 SK8 Format Select Input
9 N.C.	9 N.C.
10 N.C.	10 N.C.
11 N.C.	11 N.C.
12 GND	12 GND
13 N.C.	13 N.C.
14 N.C.	14 N.C.
15 N.C.	15 N.C.
16 N.C.	16 N.C.
17 N.C.	17 N.C.
18 N.C.	18 N.C.
19 N.C.	19 N.C.
20 N.C.	20 N.C.
21 N.C.	21 N.C.
22 N.C.	22 N.C.
23 N.C.	23 N.C.
24 N.C.	24 N.C.
25 C/O Status	25 Projector Status

Format sense and control are accomplished via connection of the CP500 automation lines connected to DA20 CTRL0 through CTRL7. The DA20 monitors the CTRL lines to detect when various formats are selected and asserts Format 10 depending on which mode the DA20 is in. In all cases, the control lines must be low for a minimum of 80ms to be recognized as valid format assertions. The DA20 will assert various control lines depending on which mode is selected on the DA20. See the DA20 Users' Manual for specific information related to the DA20 modes of operation and the Auto Digital feature.

The DA20 switches to Format 05 by holding CTRL2 low for approximately 150ms and returns to Format 10 by asserting CTRL4 low for approximately 150ms.

Note that if a custom format screen is constructed on the CP500, Formats 05 and 11 must not be moved from the factory pre-set locations if connected as described in the CP500 to DA20 connection diagram. If the wiring harness is modified, these formats can be moved to different soft keys. Please see the CP500 Installation Manual for specific information on the operation of the automation connector on the CP500.

SECTION 3

CAT. NO. 700 DIGITAL SOUNDHEAD ALIGNMENT

- 3.1 Cat. No.700 Digital Soundhead Alignment
- 3.2 Test Setup with Oscilloscope
- 3.3 Focus Adjustment
- 3.4 Exciter Lamp Level Confirmation and Adjustment
- 3.5 Film path Alignment
- 3.6 Optical Alignment

3.1 Cat. No. 700 Digital Soundhead Alignment

Mechanical alignment of the Cat. No.700 Digital Soundhead consists of making sure the film path through the Digital Soundhead is aligned with the path through the rest of the projector.

1. Thread a length of film from supply reel through the Digital Soundhead (refer to the threading diagram located on the soundhead), and on through the projector as you would any film.
2. Apply tension to the film and inspect for equal tension on both edges of the film.
3. Check for uneven forces on the rollers, or twisting of the film.
4. When the path is aligned, tighten the soundhead mounting bolts and reel arm.

3.2 Test Setup with Oscilloscope

The following test setup will enable adjustment of focus and confirmation and adjustment of lamp level and optical alignment.

1. Make sure power to Cat. No.700 Digital Soundhead is provided. Power to the DA20 should also be turned on.
2. Remove the DA20 front panel (see Section 8).
3. Connect a probe from Channel 1 of a 20MHz or greater bandwidth oscilloscope to the VIDEO Test Point (TP1) on the Cat. No.670 Video Acquisition Card in slot 12 of the DA20(leftmost card), with the ground lead attached to VGND (TP2, just below TP1).
4. Connect a second probe from the scope's Channel 2 to the CLAMP signal test point (TP3) to trigger the scope. Connect the second probe's ground wire to DGND (TP7).
5. Set the trigger source on the scope to Ch. 2.

6. Adjust the Ch 2 vertical trace position to move the trace off the screen. It is not necessary to view this signal once triggering has been established.

Cat. No.670 Video Board (DA20 slot 12) Test Points:

VIDEO	TP1 (white)	The CCD video signal
VGND	TP2 (black)	Ground reference for Video signal
CLAMP	TP3 (green)	Horizontal Sync. to view Video scan.
TRACK	TP4 (brown)	Perforation rate - check for 96Hz
+15	TP5 (yellow)	+15V power supply rail
+5	TP6 (red)	+5V power supply rail
DGND	TP7 (black)	Digital ground reference
-15	TP8 (blue)	-15V power supply rail

Adjust the scope for 1 horizontal trace across the screen, and adequate vertical gain (approx. 2 sec/div. horizontal, 1 V/div. vertical). With a Dolby Digital film threaded and running in the projector, observe the video waveform. (see figure in Section 3.3).

3.3 Focus Adjustment

Cat. No.700 Digital Soundheads are factory adjusted and should not require adjustment during installation. If the soundhead has become misadjusted, focusing may be performed. Using the setup as above, adjust the objective lens/CCD assembly in the reader head by loosening the 2mm hex socket set screw (located below the lens bore) which holds the lens/CCD assembly in place, and moving the assembly back and forth. There are two methods for moving the assembly. A flat blade screw driver inserted in the oval slot above the lens can be twisted to slide the assembly. Alternately, if the CCD circuit board cover is removed, the assembly can be moved back and forth with the thumb and forefinger. The best focus is achieved when the scope pattern has minimum brightness in the center of the trace. There will always be some light here; one is looking for the most "focused looking" display, with minimum brightness inside the envelope. This should correlate with minimum error rate. Re-tighten the lens holding screw.

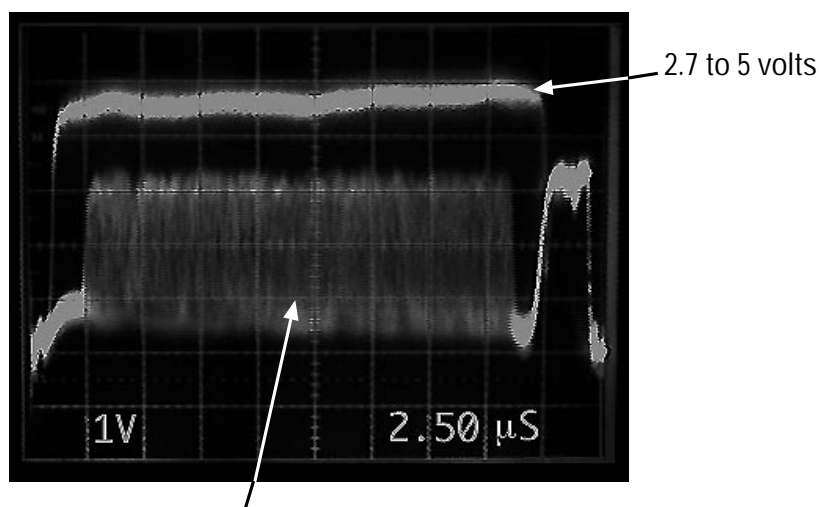

Adjust for minimum brightness in center of image.

3.4 Exciter Lamp Level Confirmation and Adjustment

The output voltage of the lamp power supply is factory-set to be between 9.5 and 10 volts. Lamp intensity has a direct relationship to the video signal voltage. The acceptable range for the peak video signal voltage (of unobstructed light through the perf hole) is between 2.7 and 5 volts (see figure in Section 3.3). Under normal circumstances, the lamp power supply voltage will never need adjustment to achieve the acceptable video voltage range. However, some combinations of individual lamp intensity and projector speed may result in a video signal outside the 2.7 to 5 volt range. In that case, it may be necessary to adjust the lamp power supply. See diagram for adjustment location (VR1). Do not adjust voltage above 10 volts at output of power supply.

If the top of the video waveform is not reasonably flat (± 1 division), check for dirt, dust, or other obstruction to the light path, and clean (see Section 7).

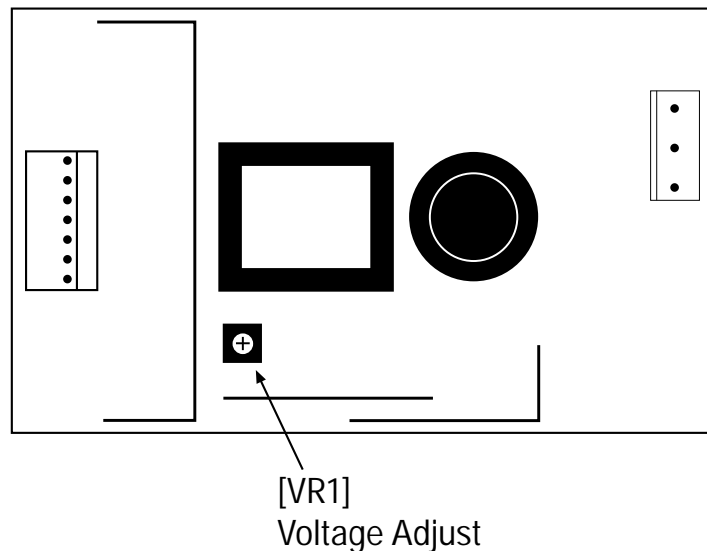

3.5 Film Path Alignment

The film path is aligned during manufacture and should not require adjustment during installation. The procedure for confirming or adjusting the film path follows.

The flanged guide roller on the top tension arm (the spring loaded roller between the sprocket and drum) is the only film guide with provision for lateral adjustment. The specification for its position is based on nominal film position. The film should be guided so that the inner edge of the film is 25.4mm (+0.1-0.1mm) from a machined reference surface on the soundhead housing (19mm diameter unpainted spot between the sprocket boss and the light pipe). The outer edge of the flange on the guide roller therefore should measure 61.9mm from the reference surface. To adjust the position of the guide, the rear panel of the soundhead, the flywheel, and the tension arm spring must be removed. See the diagram below for the location of the two screws that control the position of the roller. Before loosening the clamp screw, note the angular position of the spring arm with respect to the tension arm on the front of the soundhead (return the arm to the same angular relationship prior to tightening). The lateral adjustment screw can be turned after the clamp screw is loosened. A quarter turn of the adjusting screw will move the lateral guide roller approximately 0.1mm.

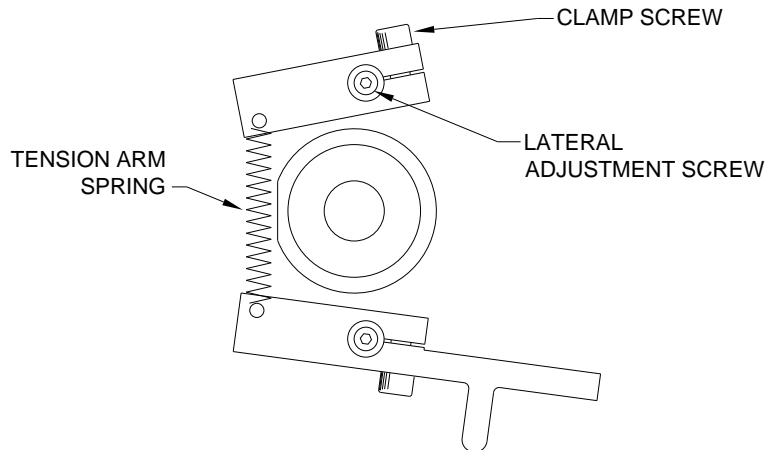

3.6 Optical Alignment

The soundhead is optically aligned at manufacture and should not require adjustment unless the CCD circuit board has been moved or replaced (the CCD sensor is located on the CCD circuit board). Optical alignment of the sensor depends on the position of the circuit board. Two adjustments of CCD board position are possible: lateral and rotational (azimuth). The procedure for confirming or adjusting the position of the CCD board follows.

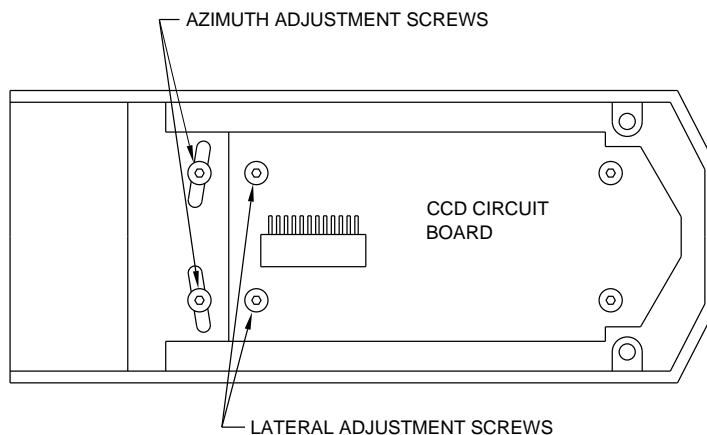

Lateral

Lateral position can be confirmed if the video signal (of unobstructed light through the perf hole) on the oscilloscope falls in the center of the total CCD video signal. To center the video signal on the scope do the following:

1. Use the scope setup described in 3.2 above, observe both channel 1 and 2.
2. Run a digital film through soundhead.
3. The scope image should be adjusted to look like the diagram below.
4. If the CCD circuit board is aligned, the video signal of light through the perf hole will be centered between the falling edge of clamp (trigger) trace and the rising edge of clamp trace. As in the diagram, distance "X" will be equal on each side of the video signal.
5. To re-align the CCD board, first loosen the two lateral adjustment screws shown in the diagram of the circuit board. Move the board laterally while observing the

image on the scope. When the video trace is centered with respect to the clamp trace, tighten the screws.

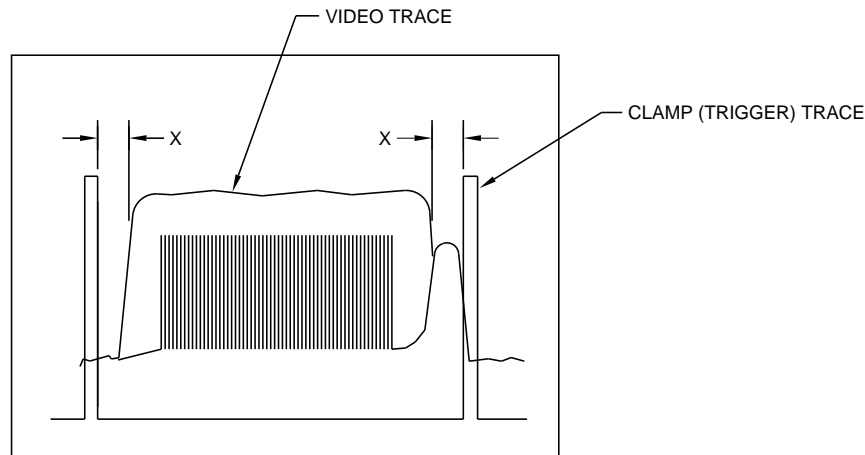

Azimuth

The azimuth adjustment controls the angular position of the CCD board with respect to the film. To adjust the azimuth of the CCD:

1. Loosen the two azimuth adjustment screws shown in the diagram. The focus adjustment screw will also need loosening slightly
2. Rotate the CCD circuit board assembly clockwise and counterclockwise and observe the LEDs on the Cat. No.671 boards in slots 2 and 3 of the DA20.
3. Center the rotation of the CCD circuit board assembly between the angles at which synchronization pattern finding begins to fail. See discussion below.
4. Tighten azimuth adjustment screws and then refocus the soundhead.

Verification of synchronization pattern finding

The Cat. No.671 cards in slots 2 and 3 are responsible for resampling and locating sync patterns in the digital data. These cards display **sync found** on their LEDs. The 8 LEDs from top to bottom display sync found as follows:

- Upper Left found first pass
- Upper Right found first pass
- Lower Left found first pass
- Lower Right found first pass
- Upper Left found at all
- Upper Right found at all
- Lower Left found at all
- Lower Right found at all

If any of these LEDs are constantly unlit, this may indicate improper positioning of the film or CCD circuit board.

Proper adjustment of position, intensity and focus will be verified by observing no error light flashing and minimum error rate displayed on the Cat. No.673 Fifo/Resources/Error Correction/Delay board (slot 15). See Section 8.

SECTION 4 MODEL DA20 ALIGNMENT

- 4.1 Cinema Processor Type Selection
- 4.2 Digital Soundhead Delay Adjustment
- 4.3 Digital Surround Delay Adjustment

4.1 Cinema Processor Type Selection

The top rotary switch on the Cat611A Cinema Processor Interface Card is used to select the appropriate Cinema Processor type and operating mode. Setting this switch correctly is necessary in order for the DA20 to properly sense format assertions and to enable or disable Auto Digital mode. The following table describes the CP Type switch selections:

CP Type Switch Setting	Cinema Processor and Mode
0	Do Not Use (LEDs will Flash)
1	CP55 Auto Digital
2	CP45/65/500 Auto Digital
3	CP200 Auto Digital
4	Do Not Use (LEDs will Flash)
5	CP55 Auto Digital Disabled
6	CP45/65/500 Auto Digital Disabled
7	CP200 Auto Digital Disabled
8	Do Not Use (LEDs will Flash)
9	CP55 Digital Always
A	CP45/65/500 Digital Always
B	CP200 Digital Always
C	Do Not Use (LEDs will Flash)
D	Do Not Use (LEDs will Flash)
E	Do Not Use (LEDs will Flash)
F	Do Not Use (LEDs will Flash)

When the CP Type switch is set to one of the Auto Digital Enabled positions, the DA20 will automatically assert a Format 10 command to the cinema processor if the DA20 detects that the cinema processor is in a film format and there is valid Dolby Digital audio available. The DA20 will not automatically assert Format 10 unless a film format has been asserted first (01,04,or 05). See the DA20 Users manual for specific information on the operation of the Auto Digital feature.

If the user does not wish the DA20 to automatically assert Format 10, the Auto Digital disabled modes should be used. This will disable any format assertions by the DA20 except reversion assertions when playing in Format 10.

The Digital Always modes are to be used for testing and theatre alignment only. These selections disable the reversion system and force the DA20 to remain in Format 10 always. These modes are typically used for theatre test and alignment when running film loops to keep the DA20 from reverting at splices.

4.2 Digital Soundhead Delay Adjustment

On a Dolby Digital print, the digital data is located 6 frames in advance of the analog soundtrack, and 26 frames in advance of the picture. When the Digital Soundhead is mounted above the analog soundhead (as with the Cat. No. 700) a delay is necessary to synchronize the digital soundtrack with the analog track and the picture. In the DA20, this delay is set by adjusting three middle rotary switches on the Cat. No. 611A Cinema Processor Interface Card (located between the analog LED and the proj. 1 LED of the C.P. Status slot in the front panel of the DA20). SW1 (upper), SW2 (center), and SW3 (lower) select a delay from 016 to 528 film perforations. SW1 selects hundreds of perfs, and has the largest effect on delay, SW2 sets tens of perfs, and SW3 single perfs. The maximum settable delay is 528 perfs (about 5.33 seconds). The minimum delay is 16 perfs (about 170 ms) and is set by propagation delays within the DA20 decoding process.

The table below shows representative settings for a variety of common projectors in use:

Dolby External Digital Readers:

Projector	Delay	Projector	Delay
Ballantyne 35mm	247	Christie	250
Century 35mm (SA)	245	Norelco/ Kinoton	
Century 35/70 (JJ)	309	AAII (DP70)	283
Cinemacconica V5	252	Simplex 35mm (XL)	242
Cinemacconica V8	260	Simplex 35/70	298

Built-in Digital Readers:

Projector	Delay	Projector	Delay
Century w/ Component Engineering or Kelmar	20	Cinemacconica V5	28
Christie	26	Simplex w/ Component Engineering or Kelmar	26

Soundhead delay may be adjusted in either of two ways:

STATIC

1. Thread a length of Cat. No. 1010 Digital Soundhead alignment test film such that the "bullet" frame (perf 106) is located in the picture gate, and perf number 26 is located at the analog soundhead.
2. With the length threaded through the Cat. No. 700 Digital Soundhead, read the number of the perforation present in the light path of the Digital Soundhead. Dial this number into the Cat. No. 611 CP interface card switches SW1, SW2, and SW3.
3. Verify the accuracy of the setting by running a loop of Cat. No. 1010 test film and observing that the flash on the screen coincides with the pip in the sound.

DYNAMIC

1. Thread a loop of Cat. No. 1010 through the projector, analog soundhead, and Digital Soundhead. Run the projector.
2. Locate SW5, the top rotary switch on the Cat. No. 611A Cinema Processor Interface Card located between the analog signal presence LED and the Dolby Digital LED of the C.P. Status slot in the front panel of the DA20. Set SW5 to the position 9,A, or B depending on the Cinema Processor type (see section 4.1)
3. Monitor audio from the center channel of the DA20 while simultaneously monitoring audio from the analog tracks through the Cinema Processor. This may be accomplished by setting the cinema processor to format 05 (SR) and monitoring the analog audio normally, while listening to digital audio from the DA20 on a separate monitor circuit. Headphones may be connected to J8 pin 20 (center channel) and J8 pin 1 (signal ground) by means of an adapter to monitor the digital audio (consult Dolby Laboratories for additional information).

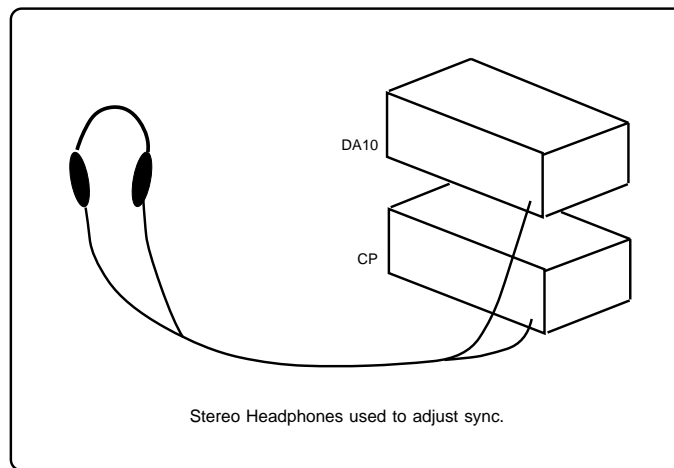

4. Adjust SW1, 2 and 3 for minimum delay between the analog track and the digital track.
5. Return SW5 to the correct Cinema Processor position (see section 4.1)

4.3 Digital Surround Delay Adjustment

Surround delay is adjusted by threading a loop of Cat. No. 1010 Digital Sync. alignment test film as above, and monitoring all channels the audio. The bottom rotary switch on the Cat. No. 611 C.P. Interface Card in slot 19 has 16 positions, (0-F) where each position adds 10ms of delay to the surround channels. The following tables show approximate delay values (in milliseconds) based on theater width and length, but because theater geometry affects the amount of surround delay required, setting of surround delay should be verified by listening at various locations in the theater. **Note:** This is not the same delay as used on the Cat. No. 150.

Delay (ms)	10	20	30	40	50	60	70	80	90	100	110	120	130	140	150
Switch setting	1	2	3	4	5	6	7	8	9	A	B	C	D	E	F

Width (in feet)

		20	30	40	50	60	70	80	90	100	110	120	130	140
	20	10	10	10	10	10	10	10	10	10	10	10	10	10
	30	10	10	10	10	10	10	10	10	10	10	10	10	10
	40	20	20	20	20	20	20	20	20	20	20	20	20	20
	50	30	20	20	20	20	20	20	20	20	20	20	20	20
	60	30	30	30	30	30	30	30	30	30	30	30	30	30
	70	40	30	30	30	30	30	30	30	30	30	30	30	30
	80	50	40	40	40	40	40	40	40	40	40	40	40	40
Length (in feet)	90	50	50	40	40	40	40	40	40	40	40	40	40	40
	100	60	50	50	50	50	50	50	50	50	50	50	50	50
	110	70	60	60	50	50	50	50	50	50	50	50	50	50
	120	70	70	60	60	50	50	50	50	50	50	50	50	50
	130	80	80	70	70	60	60	60	60	60	60	60	60	60
	140	90	80	80	70	70	60	60	60	60	60	60	60	60
	150	90	90	80	80	80	70	70	70	70	70	70	70	70
	160	100	100	90	90	80	80	70	70	70	70	70	70	70
	170	110	100	100	90	90	80	80	80	80	80	80	80	80
	180	110	110	100	100	100	90	90	80	80	80	80	80	80
	190	120	120	110	110	100	100	90	90	90	90	90	90	90
	200	130	120	120	110	110	100	100	100	90	90	90	90	90

Width (in meters)

		10	15	20	25	30	35	40	45	50
	10	20	20	20	20	20	20	20	20	20
	15	20	20	20	20	20	20	20	20	20
	20	30	30	30	30	30	30	30	30	30
	25	40	40	40	40	40	40	40	40	40
	30	50	50	50	50	50	50	50	50	50
	35	60	60	50	50	50	50	50	50	50
	40	80	70	60	60	60	60	60	60	60
Length (meters)	45	90	80	70	70	70	70	70	70	70
	50	100	90	80	80	80	80	80	80	80
	55	110	100	90	90	80	80	80	80	80
	60	120	110	110	100	90	90	90	90	90
	65	130	120	120	110	100	100	100	100	100
	70	140	140	130	120	110	110	110	110	110
	75	150	150	140	130	120	120	110	110	110

SECTION 5 THEORY OF OPERATION

- 5.1 DA20 Basic Functions
- 5.2 Discussion of Changeover Technique
- 5.3 Format Control
- 5.4 Auxiliary Data Channel

5.1 DA20 Basic Functions

The basic functions of the DA20 are:

- Video Acquisition
- Sync Finding
- Thresholding and Bit Packing
- Error Correction and De-interleaving
- FIFO Buffering and DAC Clock Generation
- Soundhead Delay
- AC-3 Transform Decoding
- D/A Conversion
- Cinema Processor Interface

Dolby Digital data is printed in the “interperf” area, between sprocket holes, adjacent to the normal analog tracks of standard 35mm release print motion picture film. Blocks of 76 X 76 “fixels” or film elements contain the audio data, along with synchronization, error correction, and auxiliary data. The film is passed through a mechanical transport, generally mounted on top of the projector, where the motion of the film is stabilized, and the interperf area is illuminated with white light. A CCD (charge coupled device) optical line scanner produces an electrical signal representing a video image of each interperf area due to the horizontal scanning of the CCD and the vertical motion of the film with respect to the CCD. This signal contains the information necessary to reconstruct the 6 audio channels.

Extensive Digital Signal Processing (DSP) techniques are applied to the video signal described above, using a variety of specific hardware and general purpose DSP cards, connected in a pipeline architecture, with each card performing part of the overall task, and passing the results to the next card over a serial data path.

Video Acquisition

The analog video signal from the CCD is digitized by an A/D converter at a rate which tracks the film speed. The converted samples are written into a bank of RAM to form an image of the interperf area in RAM. Sequential interperf images are transferred to one of four DSPs on two dual DSP cards where the images may be processed and data extracted.

Sync Finding

Each block of RAM is searched by the associated DSP card for synchronization patterns in the four corners of the image. When sync. is found, the locations of the bits within the image are calculated, and the values at those locations are obtained. An array of these samples is then further processed.

Thresholding and Bit Packing

Each dual DSP card then accomplishes Thresholding on the block of 5776 8-bit values representing the center of each bit on the film, for each interperf area. Based on the statistics of light and dark bits, which are accessible via "mailbox memory" from each DSP, a threshold value is derived, above which a fixel is determined to be clear, representing a digital "1", and below which the fixel is determined to be a "0". Having reduced each 8-bit sample value to a single bit, each DSP packs groups of 8 bits of data and 8 a bit of erasure information into a serial stream, and passes this block of 722 words to the next stage.

Error Correction and De-interleaving

The System Services Card (FIFO, Resources, Error Correction, Delay) accepts blocks of data alternately from each of the video processor DSPs, recombining the separately processed alternate perf data streams into a single AC-3 coded data stream. Reed-Solomon Error correction decoding is performed, using check bytes encoded during the film recording process to correct errors in the data due to dirt, scratches, misalignment, or illumination non-uniformity. The data, having been interleaved within a perf to reduce the effect of block errors (dirt, etc.) is now de interleaved, returning the data to the format used by the AC-3 decoder.

FIFO buffering and DAC Clock Generation

The data leaving the Error Correction process comes in bursts of 256 words approximately every 10 milliseconds, depending on film speed. The DSP of the System Services card implements a FIFO (First-In-First-Out) buffer to smooth out the bursts of data from the Error Correction process into a steady stream of data to the Transform Decoder section, while reconciling any difference in average data rates between the incoming data and the output sample rate of the audio. Using fullness of the buffer as the controlling parameter, the FIFO card slowly adjusts the frequency of the output sample clock until equilibrium is reached.

Soundhead Delay

A delay is required in the DA20 to compensate for the time between when the data is read (at the Digital Soundhead) and when the audio is to be reproduced in sync. with the picture. Dolby Digital data is recorded 6 frames in advance of the analog sound track, which is itself placed 20 frames in advance of the picture gate. If the Digital data is read 40 frames above the picture gate, for instance, the data must be delayed by $40+20+6 = 66$ frames, or 264 perforations, or about 2-1/2 seconds. This delay is accomplished by storing incoming data in RAM and sending it out at a later time, determined by the delay setting.

AC-3 Transform Decoding

The Delayed data is now passed to a Zoran Z38000 DSP card which performs Dolby AC-3 decoding. A full explanation of this process is beyond the scope of this manual, but it may briefly be described as a method of low bit rate perceptual coding of audio data using frequency-domain information as the transmitted data, rather than conventional time-domain PCM coding. The composite data stream is separated into three sets of two-channel data. Each of the channel pairs is then fully decoded into PCM audio, and sent serially to the DAC Card.

D/A Conversion

The three two-channel PCM audio serial data streams are converted to six analog audio channels by the DAC card. Oversampling of the data is performed to simplify the requirements of the reconstruction filters following the DACs. Sample rate of the DACs is determined by the clock oscillator controlled by the FIFO card, as described above. Sixteen, eighteen, or future twenty-bit DACs may be supported by the DA20, as the transform decoded data is accurate to around 20 bit resolution.

Cinema Processor Interface

The six audio signals from the DAC card are sent to the Cinema Processor Interface Card, where they are buffered, metered, and sent to the associated Dolby Cinema Processor. This card is also responsible for format control, changeover timing, and status indication.

5.2 Discussion of Changeover Technique

Projector changeover sensing is provided through 9 way female D connector J9 on the DA20 rear panel. In single projector applications, all terminals may be left unconnected, and the DA20 will assume projector 1. If reversion to analog tracks is desired, the motor start signal must be provided, otherwise the DA20 will not revert to analog, as without a motor running, the DA20 assumes no analog track is playing. The motor start signals are used to signal the DA20 in advance of a changeover in order that the video front end can switch to video from the incoming reel prior to the actual picture changeover. The changeover to the incoming projector CCD signal will be made at a time after the Motor Start signal equal to (7 seconds minus the fixed delay value.) Removal of the Motor Start signal prior to video changeover resets the changeover timing, allowing the operator to "jockey" the placement of film in the projector for between 1.5 and 7 seconds, depending on delay setting, without initiating a changeover. Verification of changeover is confirmed by the Changeover signal at the actual instant of changeover. If no Motor Start signal is asserted, the video input follows the changeover signal.

5.3 Format Control

The DA20 is controlled by means of the Cinema Processor's format selection controls. The ID0-ID7 lines from the Cinema Processor are monitored by the DA20, which senses format changes by detecting changes in the state of these lines. When Format 10 (Dolby Digital) is selected by the cinema processor, the audio output of the DA20 will be decoded digital audio if valid digital data is being read by the soundhead. When this is not possible (as when playing an analog only print) the DA20-CPXX system will play analog audio in format 05 (SR).

Should the digital data be corrupted through perforation damage, concealment techniques will be applied for up to 4 perforations (40 ms), after which time the DA20 will revert to passing analog audio. Corrected digital data must remain valid for a period of time before switching back to the digital track.

CP200:

When the CP Type switch is set to position 3 (Auto Digital mode) and the DA20 is connected to the CP200 using a Cat. No.493 CP200 Auto Digital Interface Card, the DA20 will automatically assert Format 10 when it detects that the CP200 has been set to Formats 01, 04 or 05. This causes the CP200 to be switched to Format 10 and the audio from the CP200 Processor Unit is replaced with Dolby Digital audio from the DA20. During reversions or when another Format, such as Non-Sync, is selected, the audio path is restored between the CP200 Processor Unit and the CP200 Control Unit.

When the CP Type switch is set to position 7 (Auto Digital Disabled), any format other than Format 10 will allow the analog audio signal to pass from the CP200 Processor Unit to the CP200 Control Unit despite the presence or absence of digital audio.

CP45/CP65/CP500:

When the CP Type switch is set to position 2 (Auto Digital mode), the DA20 will assert Format 10 (S4) whenever the DA20 detects that either Format 01 (S0), Format 04 (S1), or Format 05 (S2) has been asserted and there is valid Dolby Digital audio. The DA20 will not assert Format 10 automatically unless it detects that the Cinema Processor is in one of these three formats.

When the CP Type switch is set to position 6 (Auto Digital Disabled mode), the DA20 will not assert any format commands until Format 10 has been selected.

In both Auto Digital and Auto Digital Disabled modes, after Format 10 has been selected, if the DA20 detects a failure of the digital decoding, then the DA20 will assert Format 05 (S2) and the Cinema Processor will revert to playing the audio from the analog SR track on the film. When the DA20 detects that valid digital audio is again available, then the DA20 will again assert Format 10 in either Auto Digital or Auto Digital Disabled modes.

CP55:

When the CP Type switch is set to position 1 (Auto Digital mode), the DA20 will assert Format 10 (S7) whenever the DA20 detects that either Format 01 (S0), Format 05 (S1), or Format 04 (S2) has been asserted and there is valid Dolby Digital audio. The DA20 will not assert Format 10 automatically unless it detects that the Cinema Processor is in one of these three formats.

When the CP Type switch is set to position 5 (Auto Digital Disabled mode), the DA20 will not assert any format commands until Format 10 has been selected.

In both Auto Digital and Auto Digital Disabled modes, after Format 10 has been selected, if the DA20 detects a failure of the digital decoding, then the DA20 will assert Format 05 (S1) and the Cinema Processor will revert to playing audio from the analog SR track on the film. When the DA20 detects that valid digital audio is again available, then the DA20 will again assert Format 10 in either Auto Digital or Auto Digital Disabled modes.

5.4 Auxiliary Data Channel

The Auxiliary data channel may be monitored using an RS-232 compatible device. The data format is RS-232 standard 115,200 bits/second, 8 bit data, no parity, 1 start bit, 1 stop bit. Connection to the data channel is provided through J3, a DB-9 Female connector on the rear panel. The data channel supports RS-232C signal levels. Handshaking is provided; the connector is wired as DCE with TXD on pin 2 and signal common on pin 7. Pins 4 and 6 are shorted, as are pins 7 and 8, to allow direct connection to a standard PC serial port. The connector case is wired to chassis ground.

DA20 J3 DB9 Female Pin assignments	
1	n.c.
2	Serial Data Out
3	Serial Data In
4	Connected to pin 6
5	Signal Ground
6	Connected to pin 4
7	Handshake Out
8	Handshake In
9	n.c.

5.5 Dolby Digital Decoder Block Diagram

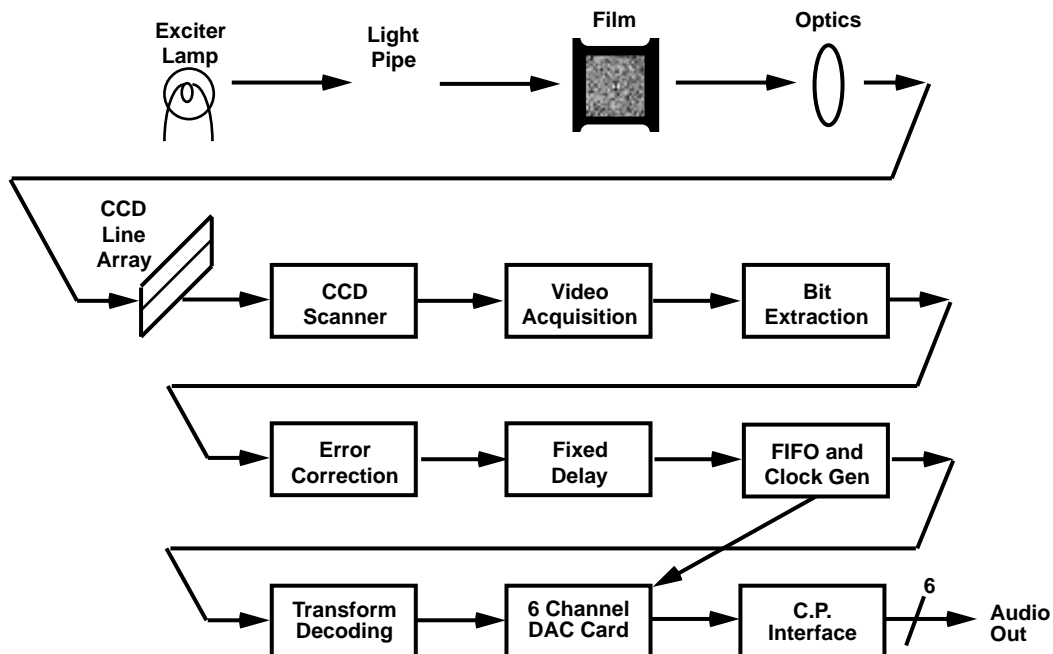

SECTION 6 OPERATING INSTRUCTIONS

- 6.1 How to Identify Sound Tracks on Prints
- 6.2 Film Threading
- 6.3 Displays
- 6.4 Format Control
- 6.5 Auxiliary Data Channel
- 6.6 Two Projector Changeover Operation
- 6.7 Operation With An Automation System

6.1 How to Identify Sound Tracks on Prints

A Dolby Digital film print or a stereo optical print (A-Type or SR), or a mono optical print should be identified as such on both the film can and leader. However, with handling the identification may be lost. If you are not sure if you have a stereo analog print, play a reel and find a section with music and/or effects only (on dialogue or narration, stereo soundtracks look much the same as mono soundtracks). Examine the soundtracks closely; on music and effects, the two soundtracks will appear to be different on a stereo print; on a mono print they are identical. If you specified a stereo print and received a mono print in error, be sure to check with your local exchange or the film distributor.

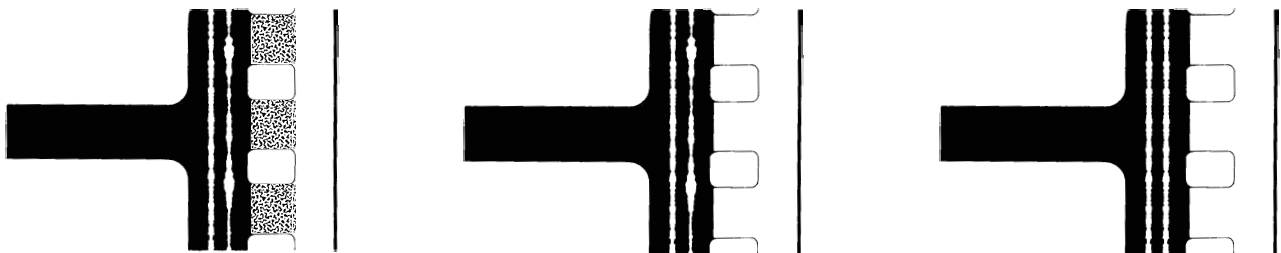

Dolby Digital Print

The digital data blocks are clearly visible between perforations next to the analog track. The analog track is Dolby SR encoded.

Analog Dolby Stereo Print

Clear differences between channels will be seen in some places along the track.

Mono Print

Both tracks are the same.

Figure 6.1 Film Sound Tracks

There is no way to tell by visual inspection if a stereo print has been encoded with a surround channel or whether it is Dolby A-type or SR encoded. However, all but a few early Dolby Stereo releases do have a surround channel. The majority of prints are now Dolby SR encoded. If you are in doubt, play the print in format 04 Dolby A-type until you have a chance to listen to the track and compare playback quality in formats 04 and 05.

6.2 Film Threading

The Cat. No. 700 Digital Soundhead is similar in many ways to a conventional analog soundhead, having a lightweight flywheel, toothed sprocket, two pad rollers, and two

dashpot-damped tension arms. The pad rollers on the toothed sprocket are coupled to allow easy film threading. A spring loaded roller arm damps variations in input film tension. Bypass rollers are provided to bypass the soundhead with either 35 or 70 mm film. Figure 6.2 shows Digital Soundhead film path threading. Care must be taken to thread the film the same way every time, so that the distance from the optical pickup point to the film gate is constant from show to show. Circuitry in the DA20 processor delays the signal read at the optical pickup by an amount set during installation. The threading must match this delay, or improper synchronization will result. **NOTE: Film tension is important. A proper loop is set when the tension arms match the white half circles. The arms must not touch, or be too far apart (approximately 5mm is correct).**

Set film path so that top and bottom tension arm rollers (A) are approximately 5 MM (1/4 inch) apart. Use the white painted semi-circles (B) for angular alignment of tension arms (C). Make sure that the rollers do not touch.

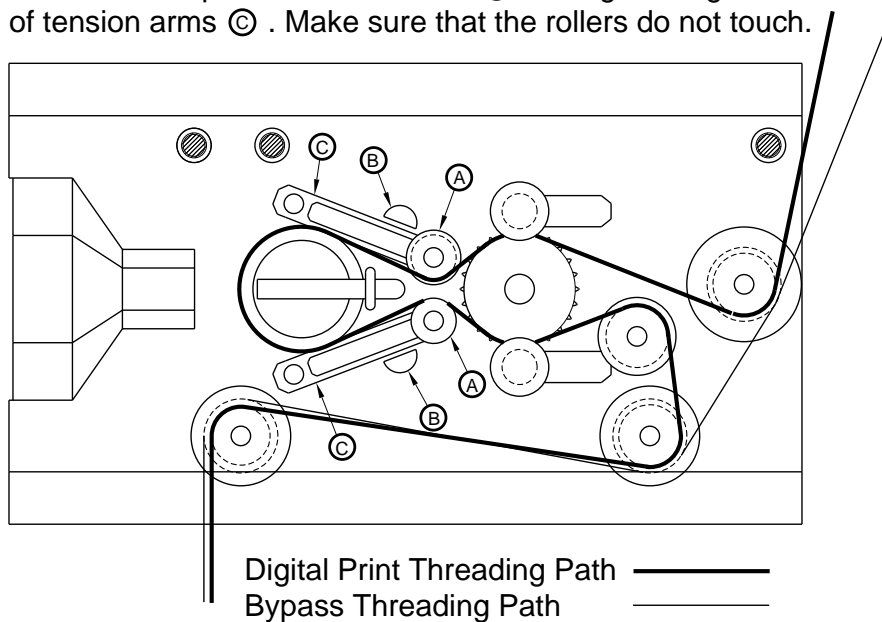

Figure 6.2 Film threading

6.3 Displays

The DA20 has eight slots in the front panel to allow sets of LEDs to be visible, indicating the activity of various circuits. The large slot in the center is used as an **error rate display** on a seven segment LED. Six of the slots show **digital audio signal level**, and the last shows **Cinema Processor Status**. Each area will be discussed below. See Section 8 for use of these displays in troubleshooting.

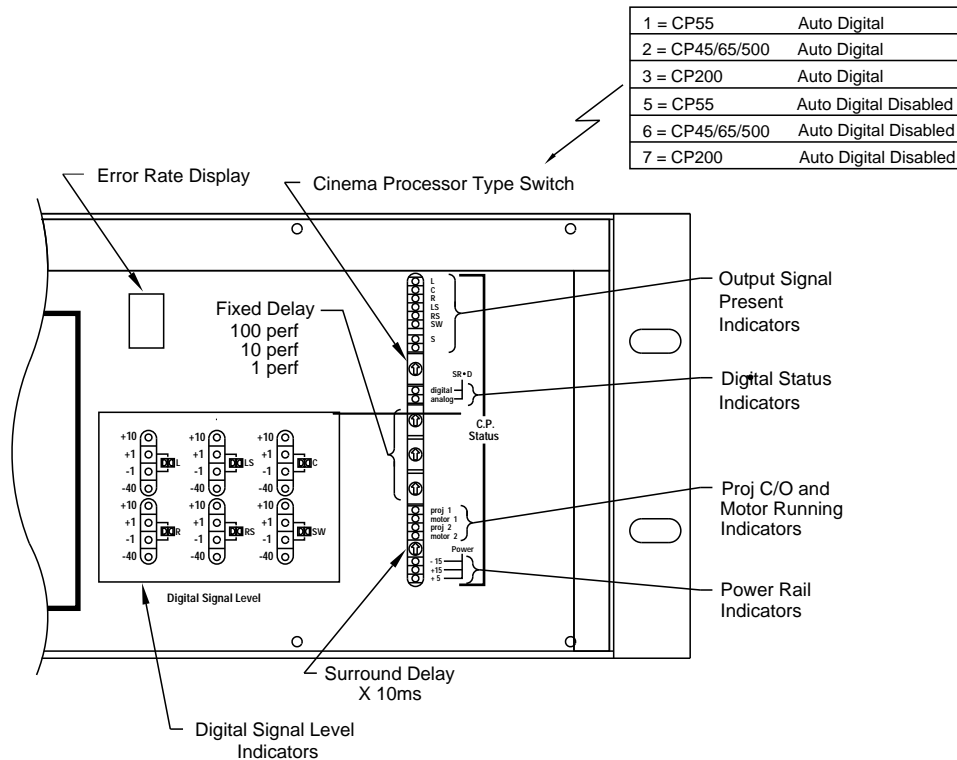

Figure 6.3 DA20 Front Panel

Error Rate Display

Following powerup, with no film running, the seven-segment display will display a “-” indicating no data on which to display error rate. When film is run, the display will show error rate of the film on a scale of 0-8 with intermediate values indicated by the right hand decimal point (0,0.,1,1.,2,2.,3,3.,4,4.5,5.,6,6.,7,7.,8,) where 0 is the lowest and 8 is the highest. The display shows “F.” when an uncorrectable block is being processed. See **Section 8.2** for further detail.

Digital Signal Level Display

Digital audio signal levels are displayed for channels **Left, Right, Left Surround, Right Surround, Center and Subwoofer** using four LEDs for each channel. The bottom LED in each set shows audio activity less than -40dB below Dolby Digital level. Equal brightness of the center two LEDs indicates “Dolby Digital level”, corresponding to an 85dB SPL in the theater. The top LED indicates activity greater than $+10\text{dB}$ above Dolby level when lit. These LEDs show that digital audio from a Dolby Digital print is being decoded.

Signal Present Indicators

Signal Present Indicators are active when the signal level is approximately -40dB or above (with respect to Dolby Digital Level). The LED brightness corresponds directly to signal level. These Indicators represent the decoded analog signal level present at the output of the DA20. In a system using a **CP200** Cinema Processor, analog audio from the cinema processor is routed through the DA20 to allow switching between the analog and the digital tracks. The LEDs indicate the decoded digital signal level when the **digital status Indicators** show that a **digital track** is selected, and the analog signal level when **analog track** is indicated (see Digital status below). In a system using other Dolby cinema processors, audio switching between analog and digital is performed within the Cinema Processor, and the LEDs will reflect only decoded digital signal level.

Digital Status Indicators

These LEDs indicate the format of the audio coming from the DA20. When the upper (**green**) LED is on, Format 10 has been selected, and the DA20 is producing decoded **digital** audio. When the lower (**yellow**) LED is on, Format 10 has been selected but the DA20 is unable to decode digital information from the film (either the film is not a Dolby Digital print, or the data is unreadable) and has switched to the **analog** track. When neither LED is on, a format other than 10 has been selected, and the digital audio track is not being reproduced.

Projector Changeover and Motor Running Indicators

The **Projector1** and **Projector2** LEDs indicate the status of the changeover line from the Cinema Processor. **Motor1** and **Motor2** LEDs indicate which projector motor(s) are running. The motor running signals are used in the timing of changeovers in a two projector system.

Power Rail Indicators

These LEDs indicate the presence of the three power supply rails in the DA20. All three should be lit when power is applied to the DA20.

Front Panel Switches

The five rotary switches shown on the DA20 front panel are for use by technicians when the DA20 is first installed and adjusted. Changing the delay switches requires the use of special test equipment. Do not arbitrarily adjust these switches.

6.4 Format Control and Auto Digital Modes

The DA20 can operate in either of two basic modes: Auto Digital and Auto Digital Disabled. These are described below:

When the CP Type switch on the DA20 is set to Auto Digital mode for a particular cinema processor type, the DA20 will automatically assert Format 10 and switch the Cinema Processor to Format 10 under certain conditions.

When the CP Type switch is set to an Auto Digital Disabled mode, the format selection is controlled by the Cinema Processor alone and the DA20 will assert no formats except when switched to Format 10 and a reversion is required. Details of operation differ depending on the type of Cinema Processor used and are described later.

When Format 10 Dolby Digital is selected, the DA20 will output decoded digital audio whenever valid digital data is being read by the soundhead. Receipt of valid digital data is indicated on the DA20 front panel when the green 'Digital' LED lights. When valid digital data is not available (for example, while playing an analog only film), the output of the DA20 / CP system will be switched to analog (Format 05, Dolby SR). The DA20 uses very sophisticated error correction techniques to allow the data to be read perfectly, even in the presence of heavy scratching or dirt. As with any digital system, the performance is perfect up to the limits of the error correction, and then degrades very rapidly. Should the digital data become corrupted beyond correction through perforation damage, then concealment techniques are applied for up to 4 perforations (40ms), then the DA20 forces the Cinema Processor to Format 05 (Dolby SR). This is referred to as a 'reversion to analog' or simply 'reversion'. Reversion is indicated on the front panel of the DA20 when

the yellow 'Analog' LED turns on. Corrected digital data must remain valid for a period of time before the DA20 will switch back to the digital audio track.

The operation of the DA20 with each Cinema Processor is described separately below:

CP55

When the CP Type switch is set to position 1, the DA20 will operate in Auto Digital mode. In this mode, the DA20 will automatically switch the CP55 to Format 10 if the following conditions exist:

- The DA20 detects that the CP55 is in a film Format (01, 04, or 05).
- The DA20 is properly decoding digital data
- There are no formats presently being asserted

If all of the above conditions exist, then the DA20 will automatically assert Format 10, eliminating the need to separately cue digital films or trailers. The DA20 will continue to assert Format 10 after any film format assertion so as to keep the CP55 in Format 10 as long as valid digital data is available. After the DA20 has asserted Format 10, if valid digital data is no longer available, then the DA20 will revert to analog by asserting Format 05 to the CP55. At this point, an automation system or operator can assert any format. The DA20 will not re-assert Format 10 until valid digital data is again available.

To disable the automatic selection of Format 10 by the DA20, there are two methods by which to accomplish this.

First, the user can rotate the CP Type switch to position 5. This disables the ability of the DA20 to assert any format commands except those associated with reversions (i.e. Format 05 when valid digital is lost and Format 10 when valid digital returns).

Second, the user can press and hold the Format 05 button on the CP55 for at least 4 seconds. After 4 seconds has elapsed, the green 'Digital' LED on the DA20 will go out. At this point, the CP55 will be in Format 05 and any format can be selected without the DA20 forcing the CP55 back into Format 10. Format 10 can again be selected from the CP55 and the DA20 will go into Format 10.

To re-enable the automatic selection of Format 10 after it has been disabled by pressing the Format 05 button, either the DA20 must be turned off and then on again, or the CP Type selector switch can be rotated out of and back into position 1.

CP45/CP65/CP500

When the CP Type switch is set to position 2, the DA20 will operate in Auto Digital mode. In this mode, the DA20 will automatically switch the CP45/CP65/CP500 to Format 10 if the following conditions exist:

- The DA20 detects that the CP45/CP65/CP500 is in a film Format (01, 04, or 05).
- The DA20 is properly decoding digital data
- There are no formats being asserted

If all of the above conditions exist, then the DA20 will automatically assert Format 10, eliminating the need to separately cue digital films or trailers.

Exception—CP45s built before mid-1997: The DA20 will not automatically switch the CP45 into Format 10 if Format 01(mono) has been selected.

The DA20 will continue to assert Format 10 after any film format assertion so as to keep the CP45/CP65/CP500 in Format 10 as long as valid digital data is available.

Once the DA20 has asserted Format 10, if valid digital data is no longer available, then the DA20 will revert to analog by asserting Format 05 to the CP45/CP65/CP500. At this point, an automation system or operator can assert any format. The DA20 will not re-assert Format 10 until valid digital data is again available.

To disable the automatic selection of Format 10 by the DA20, two methods are provided on the CP45/CP65 and one on the CP500:

(CP45/CP65/CP500): The user can rotate the CP Type switch to position 6. This disables the ability of the DA20 to assert any format commands except those associated with reversions (i.e. Format 05 when valid digital is lost and Format 10 when valid digital returns).

CP45/CP65 only: The user can press and hold the Format 05 button on the CP45/CP65 for at least 4 seconds. After 4 seconds has elapsed, the green 'Digital' LED on the DA20 will go off. At this point, the CP45/CP65 will be in Format 05 and any format can be selected without the DA20 forcing the CP45/CP65 back into Format 10. Format 10 can again be selected from the CP45/CP65 and the DA20 will go into Format 10.

To re-enable the automatic selection of Format 10 after it has been disabled by pushing the Format 05 button, either the DA20 must be turned off and then on again or the CP Type selector switch must be rotated away from and back to position 2.

CP200:

Since Format 10 can reside on any of the four format selectors on the CP200, the operation of the DA20 with this Cinema Processor is different.

When power is first applied to the DA20 with the CP Type switch set to position 3, the DA20 will sequentially select formats A through D, looking for Format 10. The DA20 will remember which format selector is set to Format 10 and will select this format whenever valid digital data is detected. The DA20 will scan the four format selectors up to 10 times. If no Format 10 is detected, the DA20 will disable the auto-digital feature as it will not know which format selector to assert.

As soon as the DA20 detects Format 10 on one of the format selectors, it will stop scanning the CP200 and begin normal operation. In either case, the CP200 will be left in whatever format is selected by selector D, regardless of the wakeup format chosen on the CP200.

If Format 10 is detected on one of the format selectors, the DA20 will automatically assert that format whenever the following conditions are met:

- The DA20 detects that the CP200 is in Format 01, 04, or 05 as indicated by the state of the Format Buss line.
- The DA20 is decoding valid digital data.

If all of the above conditions exist, then the DA20 will automatically assert Format 10 thus eliminating the need to separately cue digital films or trailers. The DA20 will continue to assert Format 10 commands after any film format assertion in order to keep the CP200 in Format 10 as long as valid digital data is available.

After the DA20 has asserted Format 10, if valid digital data is no longer available, then the DA20 will revert to analog. Though the CP200 will remain in Format 10, the yellow 'Analog' LED will light and the audio signal path will switch to the analog SR track. At this point, an automation system or operator can assert any format. The DA20 will not re-assert Format 10 until valid digital data is again available.

To disable the automatic selection of Format 10 by the DA20, two methods are provided in CP200 installations.

First, the CP Type switch can be set to position 7. This disables the ability of the DA20 to assert any format commands except those associated with analog reversion when in Format 10.

Second, the 'GO' button on the CP200 can be pressed and held for at least 4 seconds. After 4 seconds has elapsed, the green 'Digital' LED on the DA20 will go off and the 'Analog' LED will flash. At this point, the CP200 will be playing the analog SR track and any format can be selected without the DA20 forcing the CP200 back into Format 10. If Format 10 is again selected, the DA20 will remain in analog reversion mode thus forcing the CP200 to play the analog SR track. Auto-digital mode can not be re-enabled unless the DA20 is turned off and then on again or the CP Type switch is rotated out of and back into position 3. This will cause the DA20 to re-scan the CP200 format selectors and look for Format 10 again and therefore should not be done while film is playing.

Power Failure:

If for any reason the DA20 loses power or resets while in format 10, it will send a format 05 command to the cinema processor. This prevents loss of sound due to DA20 failures or power loss. This will happen regardless of the position of the cinema processor type switch.

6.5 Auxiliary Data Channel

An auxiliary data channel is available on the DA20 rear panel (J9) and requires an RS-232 compatible device. Refer Section 5 for technical data on this feature.

6.6 Two Projector Changeover Operation

The DA20 "changes over" between Cat. No.700 Digital Soundheads by switching between digital data signals at a time in advance of the actual picture changeover. The data on the film is read by the Digital Soundhead ahead of the picture gate by typically 1-1/2 seconds. A delay circuit in the DA20, set during installation, compensates for this "early" reading of data. In order for a changeover to be seamless, the switchover to the incoming digital data must happen "early" as well. The Motor Start signal (a contact

which closes when power is applied to the projector) is used to initiate the digital changeover. Digital changeover occurs at eight seconds minus the amount of delay set at installation. Eight seconds is the time between the motor start cue at the end of a reel and the last picture frame on that reel. If the Digital Soundhead were located at the analog soundhead position, no fixed delay would be required, and the digital changeover would happen simultaneously with the picture changeover. Any amount of delay added to the digital signal to compensate for "early reading" (ahead of the analog soundhead) must be subtracted from the 8 seconds to get the time that the digital signal must be switched after the motor start.

6.7 Operation With an Automation System

The DA20 may be used in conjunction with any standard automation system, but the following guidelines must be followed:

When used with a CP45, CP55, CP65 or CP500, the automation system must use momentary Cinema Processor format select lines. The DA20 senses and controls these lines to switch between digital and analog as required. If format lines are held continuously, incorrect operation will result, and this situation will need to be corrected.

When used with a CP200, the automation system controls the Cinema Processor, which sends a signal to the DA20 indicating that digital sound is desired. The DA20 responds with a signal indicating that digital audio has been decoded and is present on its output lines, or that such decoding is not possible. No direct connection between the automation system and the DA20 is used.

SECTION 7

MAINTENANCE AND ADJUSTMENTS



Remove power before removing circuit boards. Always use static precautions.

- 7.1 Digital Soundhead Maintenance
- 7.2 Print Cleanliness
- 7.3 Adjustments

7.1 Digital Soundhead Maintenance

The Cat. No.700 Digital Soundhead should be kept clean and free of dust and dirt for best performance, just like your analog soundhead. Wiping the external surfaces with a clean cloth on a regular basis will keep the head looking new. The optical path should be inspected regularly and kept clean with a photographer's lens cleaning kit (available from most camera stores). Use care not to scratch the lens. The film path (rollers and drum) should be cleaned regularly, as you would on the projector. No acetone, carbon tetrachloride, or other dangerous cleaners should be used.

Replacing the Exciter Lamp

The exciter lamp in your Cat. No.700 Digital Soundhead has been designed for long life and should provide over 8000 hours of reliable use under normal circumstances. Routine replacement will depend on your theater's hours of operation. To replace the exciter lamp, carefully remove the six screws holding the rear cover/power supply of the Digital Soundhead. Allow the lamp to cool if necessary. With the rear cover removed, the lamp will be visible but still attached to the rear cover assembly by its two supply wires. Slide the lamp out of its base. Carefully remove a new lamp from the protective box, and using gloves or a clean, lint-free cloth, replace the lamp in the socket. Be careful not to touch the bulb or inner surface of the reflector in the lamp. If either is accidentally touched, carefully clean the area with isopropyl alcohol when the bulb is cool. Slide the lamp back into its base in the soundhead, replace the rear cover assembly and tighten the six screws.

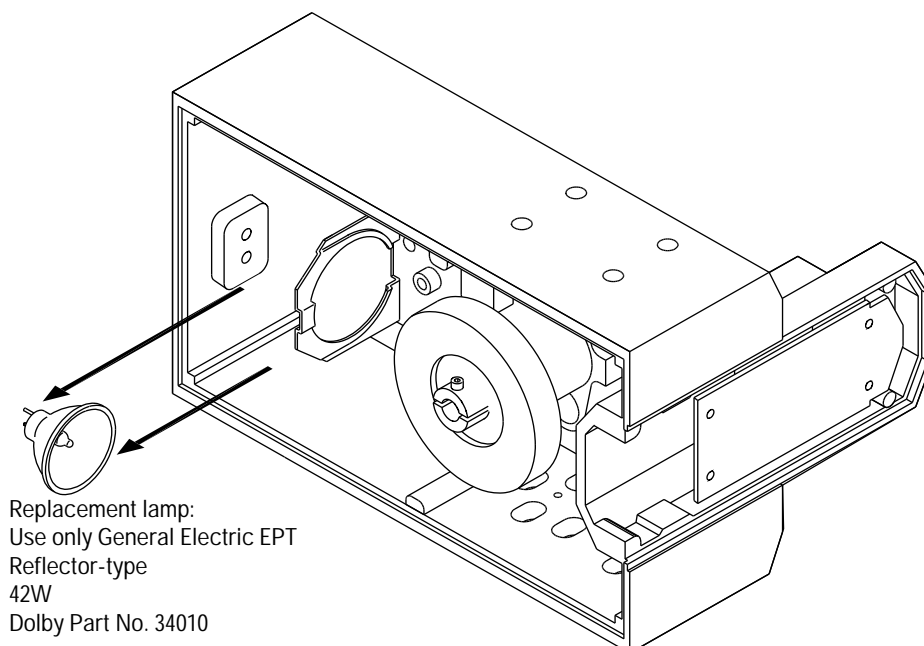
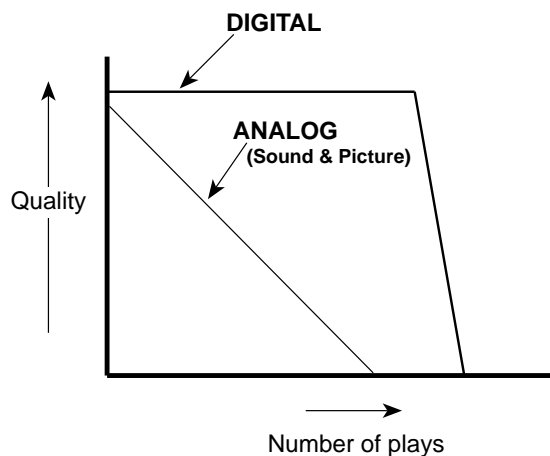

Figure 7.1 Digital Soundhead Exciter Lamp Replacement

7.2 Print Cleanliness

As with any soundtrack, keeping the print clean will give best performance. The Dolby Digital print format has robust error correction information encoded along with the audio data, and the DA20 uses a powerful digital error correction technique, allowing the data to be read perfectly even if scratches and dirt are present. However, best performance will be obtained if the print is kept clean. Standard film cleaners will provide good results.

The sound quality of the digital track has properties unlike those of an analog track with regard to print wear. With any analog track, print wear will degrade quality in a more or less linear fashion; the more wear, the lower the quality of the sound. With a digital soundtrack, wear will have no audible effect until the picture quality is degraded beyond use. At this point, wear may exceed the error correction capabilities of the decoder, and switching to the analog track will occur.



7.3 Adjustments

Routine adjustments are not required on the DA20 under normal use. Adjustments for cinema processor type, soundhead delay, surround delay, focus, and film path alignment are made during installation, and should not be attempted by the operator. Small adjustments may not affect the sound under most circumstances, and no changes will be heard, but improper adjustment may reduce the safe operating area within which all errors can be corrected. Proper test equipment is required. Refer to the DA20 Installation manual for further information.

Caution: There are no user serviceable parts inside the DA20. To avoid electric shock, do not attempt any repairs. Refer all servicing to qualified personnel.

SECTION 8

UNIT SERVICING / IN CASE OF DIFFICULTY

- 8.1 Troubleshooting During the Show
- 8.2 Problem Identification
- 8.3 Test Mode Operation
- 8.4 Starting and Program Loading
- 8.5 Failure in Digital Equipment

8.1 Troubleshooting During the Show

Your theater sound system consists of a number of critical audio components in addition to the Dolby DA20 system. Thus, the first step when something goes wrong with the sound is to find the source of the problem. The troubleshooting chart for your cinema processor can often be helpful. If indications are that the fault lies in the DA20, the procedures in the following paragraphs may be useful.

If you are unable to solve the problem using the information which follows, call your service engineer. If he or she is unavailable, you may also call Dolby Laboratories' 24 hour emergency number in San Francisco for expert advice: (415) 558-0200. You will be asked to leave your name and number, and a Dolby Engineer will call you back promptly.

1. If Digital Sound is Lost

- Switching to the analog track will occur if the Digital Soundhead is playing film which is not in Dolby Digital format, or if the digital blocks have become unreadable due to an obscured optical path or print damage. If frequent switching occurs, check for print and optical path cleanliness.
- Check to make sure power is supplied to the DA20 processor chassis and the Digital Soundhead exciter lamp.
- If power is present at the Digital Soundhead, but the exciter lamp is not lit, the lamp needs to be replaced. Refer to page 2-1 for information on replacing the exciter lamp.
- If you are sure that power is applied to the DA20, but no LEDs on the front panel are on, check the fuse in the power entry module on the rear of the DA20. If it appears blown, replace with a spare fuse of the type and value specified on the rear panel of the DA20.
- Check the video cable(s) from the Digital Soundhead(s) to the DA20 and make sure both ends are properly attached.
- If the Auto Digital feature is enabled, disable it using the following method:

CP45 / CP55 / CP65—Press and hold the Format 05 button on the Cinema Processor for at least 4 seconds. The "Digital" LED on the DA20 will go off.

CP200—Press and hold the “GO” button on the CP200 for at least 4 seconds. The “Digital” LED on the DA20 will go off.

CP500—Rotate the CP Type switch located on the DA20 front panel to position 6.

2. If One Channel Fails or is Distorted

This is unlikely to be a fault of the DA20. Check for analog audio path continuity. If the problem is isolated to the DA20, contact your authorized Service Engineer.

3. If Switching to Analog Does Not Restore Sound

If switching to analog occurs when in Format 10 (indicated by the yellow **Analog** LED on the DA20 front panel), but no analog sound is heard, FIRST select Format 05 (SR) by means of the Cinema Processor format selector switches. If this doesn't work, remove power to the DA20 and reselect Format 05.

4. If Difficulty with Changeover is Experienced

Correct changeover operation relies on installation of two relays which close sets of contacts when each projector motor is running. The normally open (closed when projector is running) contacts on these relays must be attached to connector J9 on the rear panel of the DA20. (Refer to Installation manual for further information.) In addition, a changeover signal from the Cinema Processor must be present and connected to the DA20. Correct operation of these signals may be observed by monitoring the **Proj1**, **Motor1**, **Proj2**, and **Motor2** LEDs on the front panel of the DA20.

5. If Synchronization is Lost

Synchronization of the digital soundtrack with the picture requires that the film path from the Soundhead to the picture gate be the same every time the projector is threaded. If two projectors are used, the path lengths must be identical. Digital Soundhead delay is set by switches on the Cinema Processor Interface Card (Cat. No.611A). If synchronization becomes incorrect during a show, press Format 10. This re-sends a delay turn-on command to the Cat No. 611A. If this does not solve the problem, then play the rest of the show in Analog, Format 05, and when time permits, run a loop of Cat. No.1010 Digital Soundhead Test Film and adjust the delay as described in Section 3.

If none of the above techniques solves your problem, make sure the Cinema Processor is **not** in format 10, and try cycling the power to the DA20. This will reset the DA20 and may cure a transitory problem.

8.2 Problem Identification

Some problems with the model DA20 may be isolated by viewing the LEDs visible through the front panel. Refer to **Section 6** for detailed information on normal front panel displays. Other problems will be revealed by removing the front panel, allowing other displays to be seen.

Circuit Board Locations

Figure 8.1 shows circuit board locations within the DA20:

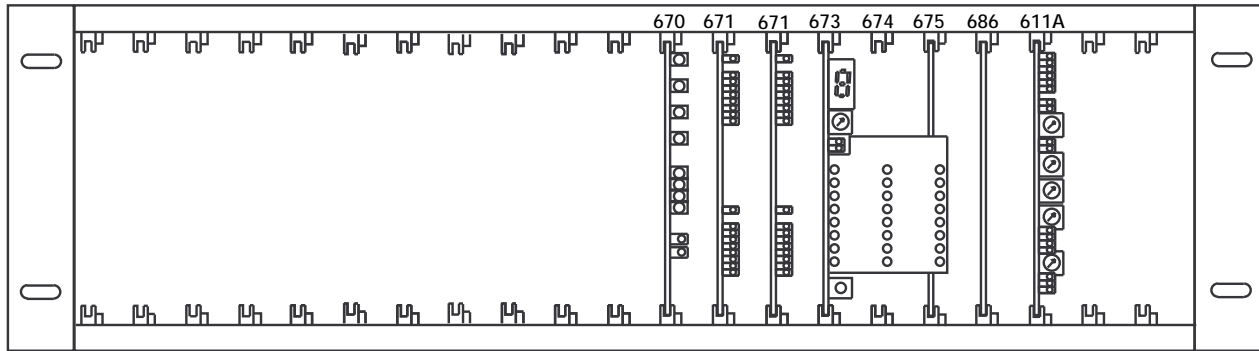

(Left to right, facing front of DA20):

Slot Number	Cat. No.	Description
1		Empty
2		reserved
3		reserved
4		reserved
5		reserved
6		reserved
7		reserved
8		reserved
9		reserved
10		reserved
11		reserved
12	670	Video Front End board
13	671	Dual DSP board
14	671	Dual DSP board
15	673	System Services board
16	674	LED board (mounted on 675)
17	675	AC-3 decoder DSP board
18	686	Hex DAC board
19	611A	CP Interface board
20		Empty
21		Empty

Figure 8.1 DA20 circuit board locations

NOTE: In order to comply with FCC regulations, the DA20 front panel must be in place and held by all 12 screws during normal operation. For troubleshooting ONLY, remove the 12 screws and the front panel and place in a safe place. After troubleshooting and repair, all 12 screws and the front panel MUST be replaced and tightened securely.

All cards must be present in the DA20 for normal operation. A circuit trace on each card passes a signal [LINK] to the Cat. No.673 System Services card which allows normal operation. A similar signal [FAULT] may be asserted by a malfunctioning DSP card. **Do not remove or install cards with power on.**

Internal Displays

Cat. No. 670 (Video board)

The Cat. No. 670 has two LEDs which indicate which Digital Soundhead is being read. DS2 (green) indicates Projector 1, DS1 (yellow) indicates Projector 2. These LEDs should match the equivalent LEDs on the Cat. No. 611 CPIO card.

Cats. No. 671 (Dual DSP boards)

The Cat. No. 671 cards responsible for resampling and sync finding (slots 13 and 14) display sync found on their LEDs. The 8 LEDs from top to bottom display sync found as follows:

- Upper Left found first pass
- Upper Right found first pass
- Lower Left found first pass
- Lower Right found first pass
- Upper Left found at all
- Upper Right found at all
- Lower Left found at all
- Lower Right found at all

A red LED above each group of eight green LEDs indicates will be lit during powerup and reset, and will go out indicating normal operation. Any red LED lighted on either Cat. No. 671 board during operation indicates a fault in that board. Normally, this will cause the Cat. No. 673 System Services card to reset the system.

Cat. No. 673 (System Services Board)

The Cat. No. 673 card in slot 15 has a single LED (Block Error) which will light whenever an uncorrectable block of data on the film is detected. Another single LED (Fault) above it indicates a fault condition on the System Services board.

7 segment LED display

This displays system status. A normal power up sequence will display **C,r,L,—**, with the **C** and **r** states going by almost too fast to see, the **L** state taking a few seconds, and a successful load being indicated by the dash.

Normal display during power up

C Performing checksum on Flash Rom contents—displays briefly (about 1/10 second)
r Resetting all cards in the DA20 (1/2 second)
L Loading system code (a few seconds)
— Successful system load, film not running

If the system does not load successfully, see **Displays Indicating Trouble** section below.

Normal display error rate

With film running, there will be a continuous display of error rate. Error rate is indicative of relative film wear and alignment. Rates of 1 up to 8 are still correctable by the error correction circuitry. **Low numbers indicate low error rate, higher numbers indicate higher error rate, mid-range is typical.** A right hand decimal point is used to display intermediate values of error rate, giving higher resolution to the display (5. is equivalent to 5-1/2). Uncorrectable data will cause a display of "F."

Displays Indicating Trouble

U (flashing) LINK not present (card missing). If the flashing U is being displayed, check for incompletely inserted cards. All cards should be fully seated for proper operation.

b Loading Baseline code—Main system code defective or incomplete

The codes listed below indicate problems with individual software modules. These codes are displayed by showing each letter in sequence and repeating as in “H-E-L-P-2-H-E-L....”

HELP0	Second stage loader not found
HELP1	Missing Baseline FRED module
HELP2	Selected module not found in ROM
HELP3	Selected module fails checksum
HELP4	Selected module not in directory
HELP5	Baseline FRED module fails checksum

Any other display Indicates failure of the FRED Card.

8.3 Determining Software Revision Numbers

The System Services Card (Cat. No. 673) in slot 15 has a rotary switch (SW1) located directly under the alphanumeric display which allows the DA20 to be switched into various test modes used in manufacture and test. The switch should be set to “0” for normal operation.

Each of the cards in the DA20 has its own piece of software, called a module. Sometimes it will be necessary to determine what the revision number is for each of these software modules.

To do this:

1. First start the system normally. Be sure that the Cat. No. 673 test mode switch is set to position “0” before you apply power to the system. It is not necessary to have film running, although this operation can be done with film playing without affecting system operation.
2. Set the Cat. No. 673 test mode switch to position 2.
3. Return the switch to position 1. Write down the reading on the alphanumeric display. This is the rev number for the Video Front End code.
4. Set the switch to position 2. Write down the reading on the alphanumeric display. This is the rev number for the AC3 code.
5. Set the switch to position 3. Write down the reading on the alphanumeric display. This is the rev number for the System Services code.

6. Continue moving the switch and writing down the alphanumeric display readings for switch positions 4, 5, 6, 7, 8, and 9.
7. Return the switch to position 0.

Check the numbers you noted against the table below:

Switch position	Code	Current rev. as of January 1997
1	Video front end	9
2	AC3	3
3	System Services	8
4	Boot	0
5	Second stage loader	1
6	System Services baseline	8
7	Video baseline	9
8	AC3 baseline	3
9	Serial port ROM load	3

The software in the DA20 is subject to continual improvement, both at the factory and by “dynamic loading” from film in the field. Therefore, the revision numbers for the modules may be higher than those shown above, or lower for units made before the date shown.

To confirm that your software is running normally you can “reboot” the system by pressing the reset button located at the bottom of the Cat. No.673 card. If, when the system boots, you see “C” and “r” go by rapidly, and “L” persist for a while before - appears on the display, all is normal.

If you see “C” rapidly followed by “b”, before “-” appears on the display, the newer versions of the code may have been corrupted and the system has loaded its baseline code. In this case, any upgrades loaded from film will have been lost. If resetting the DA20 does not cure the problem, the unit must be repaired. The dynamic loading process may then have to be repeated, depending on the repairs carried out.

8.4 Starting and Program Loading

All computer- or microprocessor-based products have certain things in common. They contain a computer of some sort, often with auxiliary input and output devices, and various kinds of memory. Some kinds of memory are permanent and some forget all when the power is turned off (volatile memory). When a product of this kind (as in the DA20) is turned on, the first thing that happens is loading the non-permanent or volatile memory with the programs stored in the permanent memory. Until this is finished, the product cannot do anything useful. This process is called “booting,” or “re-booting.” When this process is performed while the power is on, it is called “resetting,” or “warm-booting.” “Cold-booting” simply means turning the power off and back on again.

The reset switch used for warm-booting on the DA20 is a small red push-button located at the bottom of the Cat. No.673 System Services card. The front panel must be removed to get access this switch. If the front panel is on, the easiest way to boot is to cold-boot by turning the power off for a few seconds and then on again.

There are several reasons you might wish to do this. Some switch settings have different meanings during the boot process than they do after the system is loaded. For instance, some switch settings may only be read by the computer during boot and ignored thereafter. It is also possible that the programs loaded in the volatile memory have become corrupted and won't work any more. In this case, fresh copies must be read in from the nonvolatile memory before the system will work again.

In the DA20, cold-booting and warm-booting produce slightly different results. After a cold-boot the system is in analog mode, so as not to disturb the operation of any associated cinema processor until format 10 is selected. It warm boots, however, to the state it was last in— analog or digital—so as not to accidentally change formats immediately after a momentary power failure or brown-out.

Normal boot behavior in a DA20 (observed on the alphanumeric display) is:

- r (goes by very quickly)
- c (goes by very quickly)
- L (stays for about 3 seconds)
- booted and ready to go

U means something is not right (failed card or unplugged card, for example).

8.5 Failures in Digital Equipment

A failure in the DA20 will nearly always affect all channels. Therefore if only some of the audio channels are affected, the problem probably lies elsewhere.