

Gay 90's Whiz Bang

Part No. 47700
Revised June 1996

Instruction Manual Model #2014





 **GOLD MEDAL**®

FUNFOOD EQUIPMENT & SUPPLIES

Cincinnati, OH 45241-4807 USA

SAFETY PRECAUTIONS

	⚠ CAUTION
	This equipment is designed and sold for commercial use only. This equipment is not to be used by the consumer in home use. Do not allow direct contact of this equipment by the public when used in food service locations. Only personnel trained and experienced in the equipment operation may operate this equipment. Carefully read all installation instructions before operating the equipment.

	⚠ WARNING
	Always wear safety glasses when servicing this equipment.

	⚠ WARNING
	To avoid serious burns, do NOT touch the kettle while it is hot.

	⚠ WARNING
	Any alterations to this equipment will void the warranty and may cause a dangerous situation. NEVER make alterations to the equipment. Make sure all machine switches are in the OFF position before plugging the equipment into a receptacle.

	⚠ DANGER
	Machine must be properly grounded to prevent electrical shock to personnel. Do NOT immerse the kettle, warmer, or any other part of this equipment in water. Always unplug the equipment before cleaning or servicing.

NOTE

The information, specifications and illustrations contained in this manual represent the latest data available at time of publication. Right is reserved to make changes as required at the discretion of Gold Medal Products Company without notice.

INSTALLATION

Your new Antique Popcorn Machine is completely assembled. Remove all packing material and tape before starting operations. If you have ordered a popcorn wagon, it is shipped in two sections. After unpacking, set the top section onto a base or wagon.

ELECTRICAL REQUIREMENTS

Standard voltage for all domestic machines covered by this manual is 120 volt, 60 cycle, single phase, A.C. current.

OPERATING INSTRUCTIONS

CONTROLS AND THEIR FUNCTIONS

There are three switches on the popper.

LIGHT AND WARMER SWITCH

Turns on heat lamp and strip heater under the corn pan.

KETTLE MOTOR SWITCH

Turns on motor which drives the kettle agitator shaft.

KETTLE HEAT SWITCH

Turns on heat elements inside the kettle.

AMOUNT OF POPCORN AND OIL

The Gay 90's Antique Whiz Bang is equipped with a 12 oz. corn measure cup and a 4 oz. oil measure cup.

We recommend flavored and colored coconut oil. Popcorn popped in coconut oil stays fresh longer. Coconut oil does not leave the black deposits in your kettle like other oils.

CORN CHARGE - 12 ounces
OIL CHARGE - 4 ounces
FLAVACOL (Seasoning Salt) - 1½ to 2 teaspoons

POPPING INSTRUCTIONS

1. Turn KETTLE HEAT and KETTLE MOTOR switches "ON".
2. Make test pop with 3 kernels of corn and 1 oz. of popping corn. When kernels pop, you are ready.
3. Load full corn and oil charge, plus Flavacol seasoning salt into the kettle.
4. When corn has popped, dump the kettle.
5. Repeat the cycle - start with #3. Always pop 3 to 5 batches for the best popcorn.

On the final kettle of corn, it is a good idea to turn the KETTLE HEAT switch "OFF", just as the lids are forced open by the popping corn. This saves electricity, since there is plenty of heat in the kettle, and also helps eliminate smoke and odor after you have stopped popping.

CARE AND CLEANING

	<p data-bbox="813 390 1073 428">⚠ DANGER</p> <p data-bbox="500 464 1333 533">Disconnect main electrical power supply cord before cleaning to eliminate the possibility of electrical shock.</p>
---	--

Each time you finish a series of poppings, wipe the outside of the kettle with a soft cloth to remove any oil drippage on the outside of the kettle. Don't let it BURN ON. After you finish popping for the day, let the kettle cool until it is not too hot to handle, but still warm. Unplug the kettle and remove it from the machine. With a cloth, wipe out the inside of the kettle, the kettle lids, the kettle crossbar, and the outside of the kettle and underneath.

Cleaning the cabinet of your machine is easy - take a clean cloth and first wipe excess grease from the glass. Wipe the outside of the machine too. Use any glass cleaner that is recommended for cutting grease (**NO** ammonia). We find a wax cleaner to be good for cleaning the aluminum exterior of your machine. Remove the old maid pan, empty and wipe clean.

MAINTENANCE INSTRUCTIONS

	⚠ CAUTION
	THE FOLLOWING SECTIONS OF THIS MANUAL ARE INTENDED ONLY FOR QUALIFIED SERVICE PERSONNEL WHO ARE FAMILIAR WITH ELECTRICAL EQUIPMENT. THESE ARE NOT INTENDED FOR THE OPERATOR.

	⚠ WARNING
	Adequate eye protection must be used when servicing this equipment to prevent the possibility of injury.

	⚠ DANGER
	Do NOT immerse the kettle, warmer, or any other part of this equipment in water. Unplug your machine before servicing.

WIRING THE 20 AMP RECEPTACLE

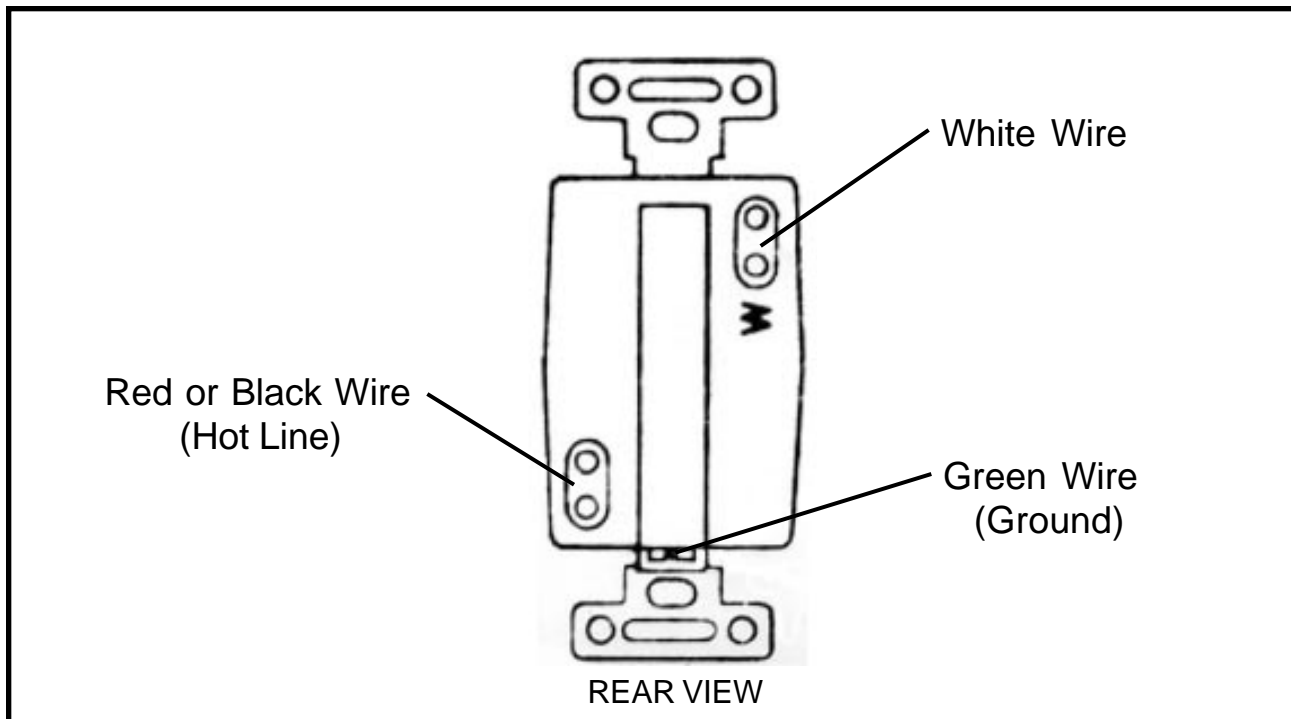

REPLACING BROKEN GLASS

Should you accidentally break a panel of glass, it can be replaced very easily without disassembling the popper.

1. Remove all loose pieces of glass.
2. Remove all vinyl strips from around the glass to be replaced. To do this, start the vinyl strips out of the channels with a knife point or similar tool. Always start at a corner. When enough vinyl protrudes, grasp it with the fingers and carefully pull it out. Set it aside as it must be reused.
3. Carefully remove the rest of the broken glass.
4. Apply decals to the new glass panel.
5. Maneuver the new glass into position. Try not to let the glass slip down into the opening in the extrusion from which the vinyl was removed. The glass should set on the small ledge as shown in the illustration below. If the glass does slip down into the opening, it will be necessary to raise the glass. Use suction cups, or a similar device.
6. Replace the vinyl, starting at the bottom edge of the glass. The vinyl is easily installed by starting at one corner and working it into the channel inch by inch. Apply pressure on the vinyl at point "A" as shown in the illustration to force it into the channel. A dull blunt object such as the eraser end of a pencil or a small round piece of wood are excellent tools.

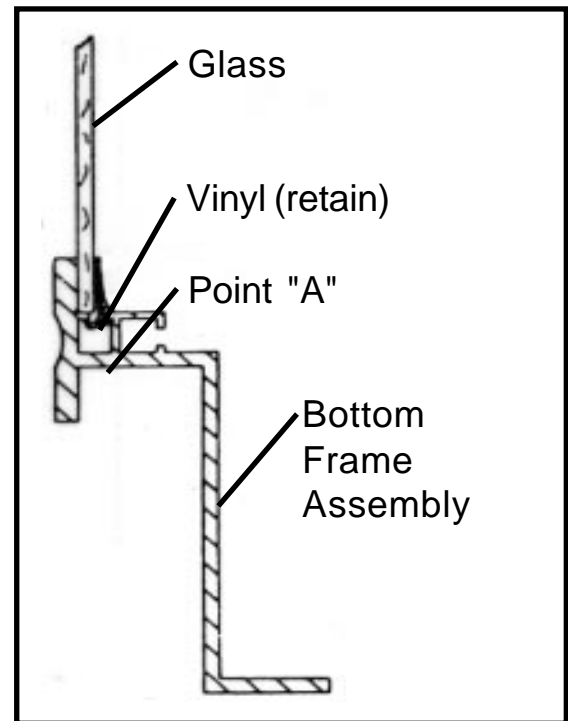

HOW TO ORDER REPAIR PARTS

1. Identify the worn or broken part by checking it with the illustrations and parts list.
2. When ordering parts, include part number, part name, and quantity required.
3. Include you model name and machine serial number (found on nameplate) with your order.
4. Address orders to:

PARTS DEPARTMENT
GOLD MEDAL PRODUCTS CO.
10700 Medallion Drive
CINCINNATI, OHIO 45214

or, place orders at:

(513) 769-7676
Fax: (513) 769-8500
E-mail: goldme19@eos.net

FRONT VIEW

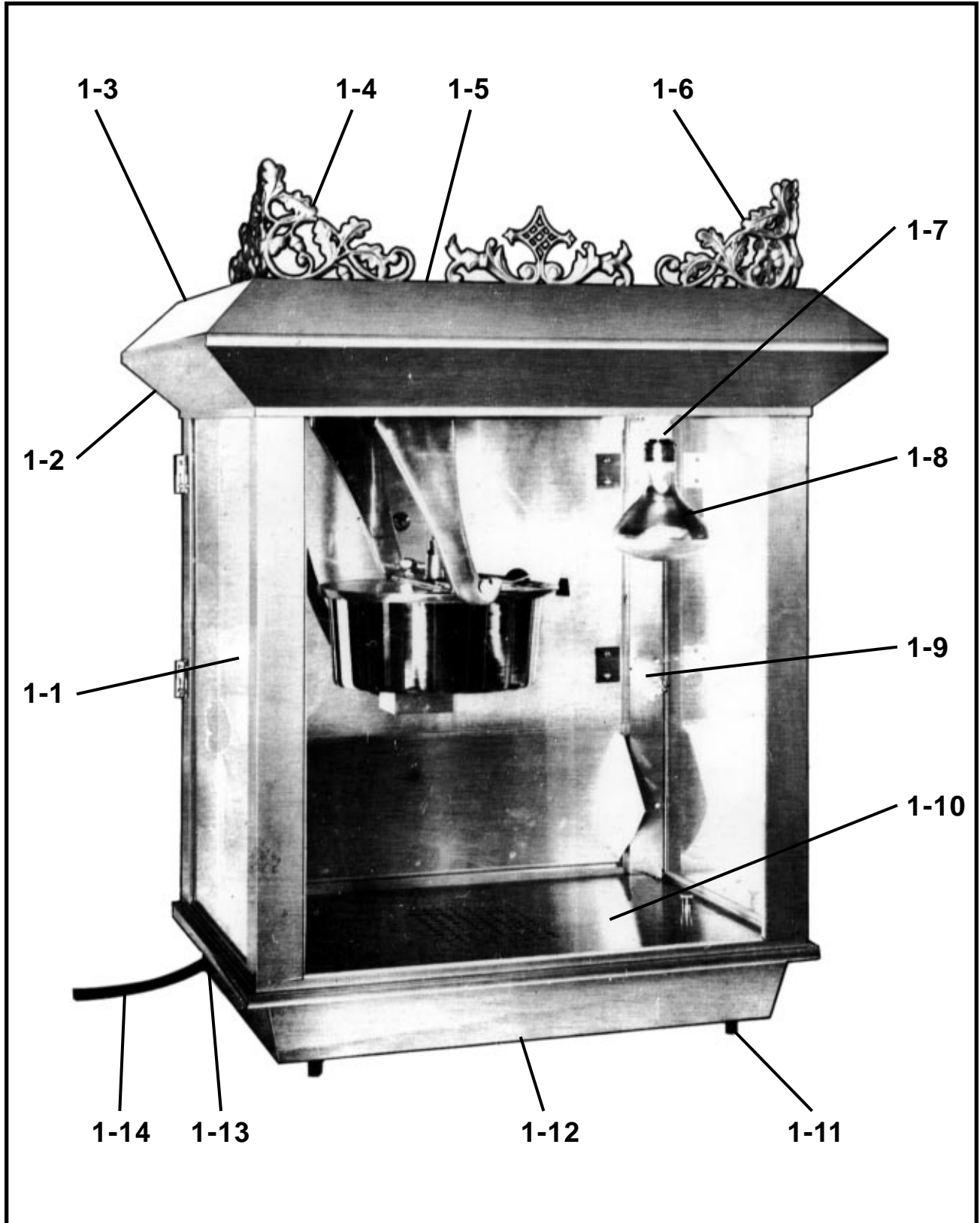

PARTS LIST - FRONT VIEW

Item No.	Part No.	Description
1-1	47309	Front Corner Post (2 Required)
1-2	47483	Lower Top Frame
	47429	U-Clip (6 Required)
1-3	47487	Upper Top Frame
1-4	47401	Top Left Ornament
1-5	47494	Top Inspection Cover
1-6	47439	Top Right Ornament
1-7	47047	Receptacle, Heat Lamp
1-8	41671	Reflector Flood
	49098	Lamp Shield (Not Shown)
	41452	Warning, Max Lamp
1-9	47592	Glass Retainer, Rear
1-10	47598	Bottom Corn Pan Assembly 120V
	47653	Cover, Corn Pan Conduit
	47562	Molded Wire Harness, Warmer
	47565	Corner Cover
1-11	47328	Glide, Delrin Foot (4 Required)
1-12	47490	Bottom Frame
1-13	47026	Grommet, Power Supply Cord
1-14	47580	Power Supply Cord with Plug
	47603	Power Supply (Model 2014C Only)
	47564	Decal, Front Glass
	47145	A-Scoop
	47148	Corn Measure Cup
	47149	Oil Measure Cup
	47679	14.7 cc Measure
	49219	Receptacle Assembly

REAR VIEW

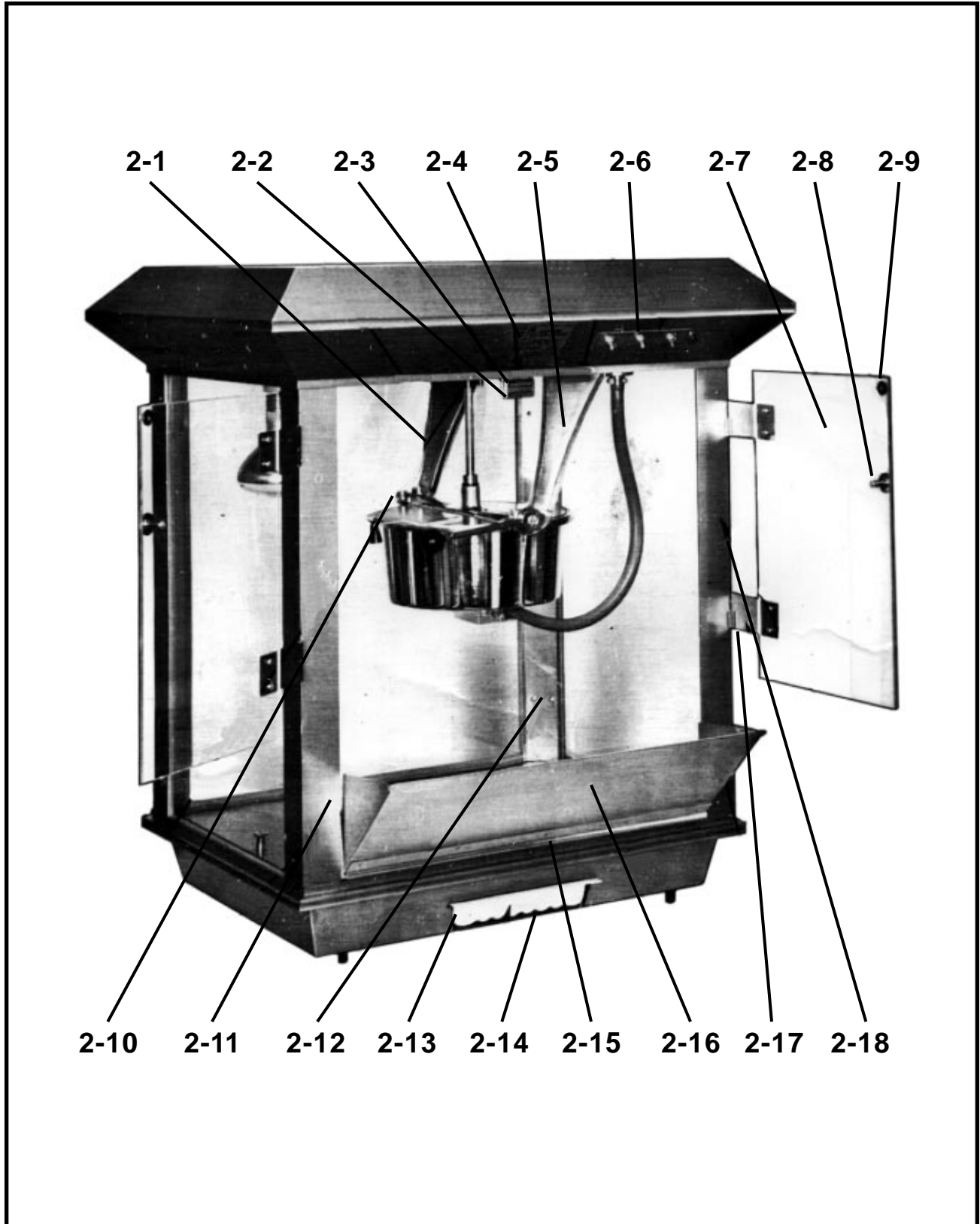

PARTS LIST - REAR VIEW

Item No.	Part No.	Description
2-1	47262	Hanger Arm, Front
2-2	47559	Magnetic Catch Mount Bracket
2-3	47561	Magnetic Catch
2-4	47480	Name / Instruction Plate
	47249	Nameplate (Model 2014 Only)
2-5	47263	Hanger Arm, Rear
2-6	77641	Switch Plate
2-7	47600	Plexiglass Door
2-8	41013	Knob, Door
2-9	47237	Striker, Door
2-10	47056	Gear Box
	47059	Spur Gear
	47058	Flange Bushing
2-11	47311	Corner Post, Left Rear
2-12	47593	Glass Retainer, Front
2-13	47336	Old Maid Pan
2-14	47386	Bottom Cover Assembly
2-15	47322	Hinge, Male Section
2-16	47337	Drop Panel Assembly
2-17	41349	Male Hinge, Short Right
	41350	Male Hinge, Short Left
	41351	Female Hinge, Long Right
	41352	Female Hinge, Long Left

TOP VIEW

Item No.	Part No.	Description
3-1	47777	Half Roof Weld Assembly
3-2	47873	Motor Plate
3-3	47057	Kettle Drive Motor
3-4	49219	Receptacle Assembly
3-5	41741	Pilot Light
3-6	47201	Switch, Kettle Heat
3-7	41672	Switch, Light and Kettle Motor
	47364	Circuit Breaker (Not Shown)
3-8	47208	Terminal Block
	47282	Snap Bushing #UB-625
3-9	47236	Snap Bushing #SB-500-6
	47343	Exhaust Blower
	47397	Elbow, Exhaust Blower

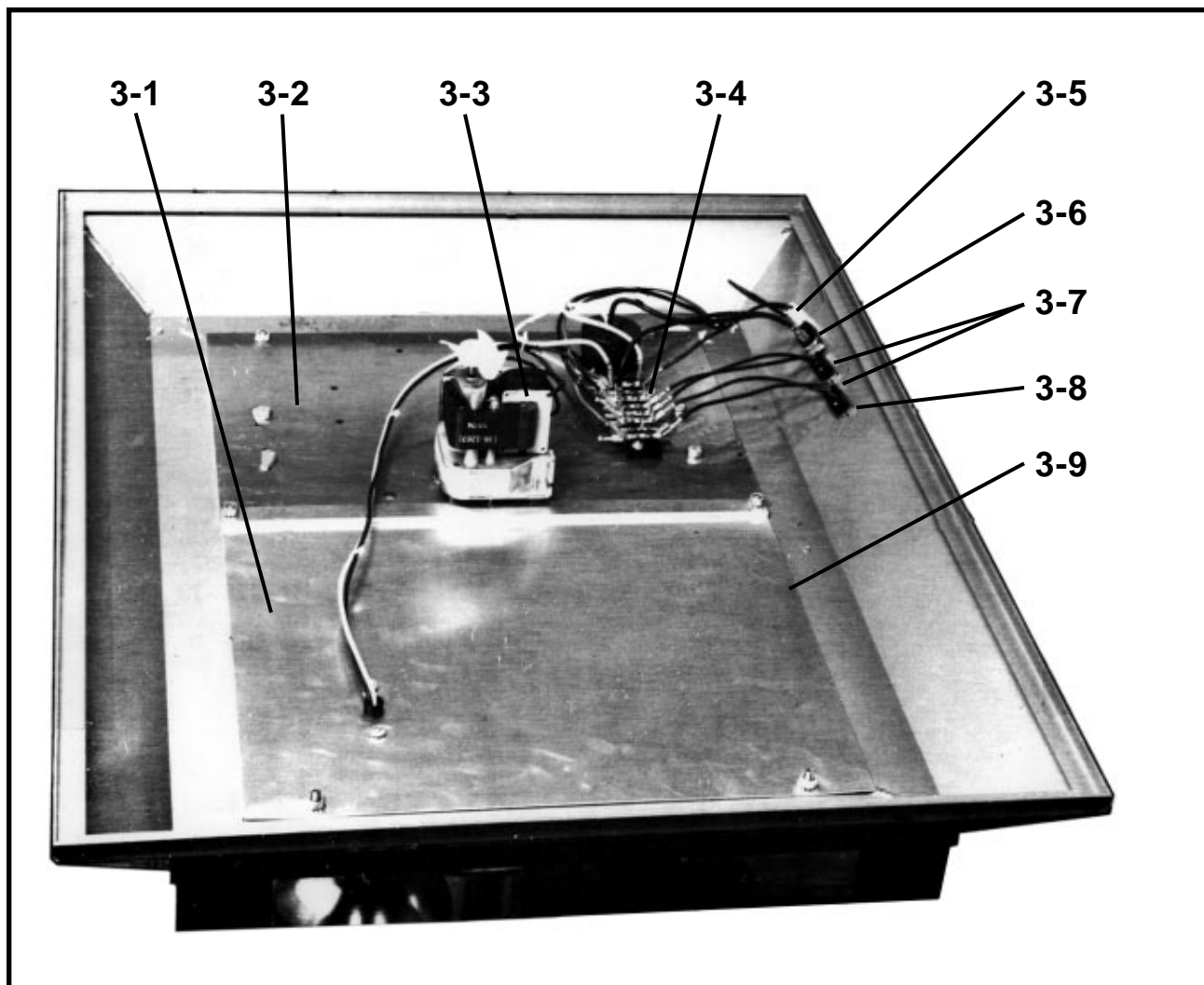

PARTS LIST - KETTLE TOP VIEW

Item No.	Part No.	Description
4-1	47107	"C" Ring, Needle Bearing
4-2	47106	Needle Bearing
4-3	47098	Agitator Assembly
4-4	47326	Set Collar, Agitator Shaft
4-5	47097	Bushing, Cross Bar
4-6	47111	Lid Lifter, Kettle
4-7	47120	Knob, Lid Lifter
4-8	47059	Spur Gear
4-9	47113	Kettle Lid, Rear
4-10	47095	Kettle Crossbar with Bushing
4-11	47154	Warning Plate, "Do Not Immerse"
4-12	47325	Set Collar, Dump Handle
4-13	47247	Kettle Lid, Front with Lifter
4-14	47109	Dump Handle w/ Knob & Collar
4-15	47110	Knob, Dump Handle

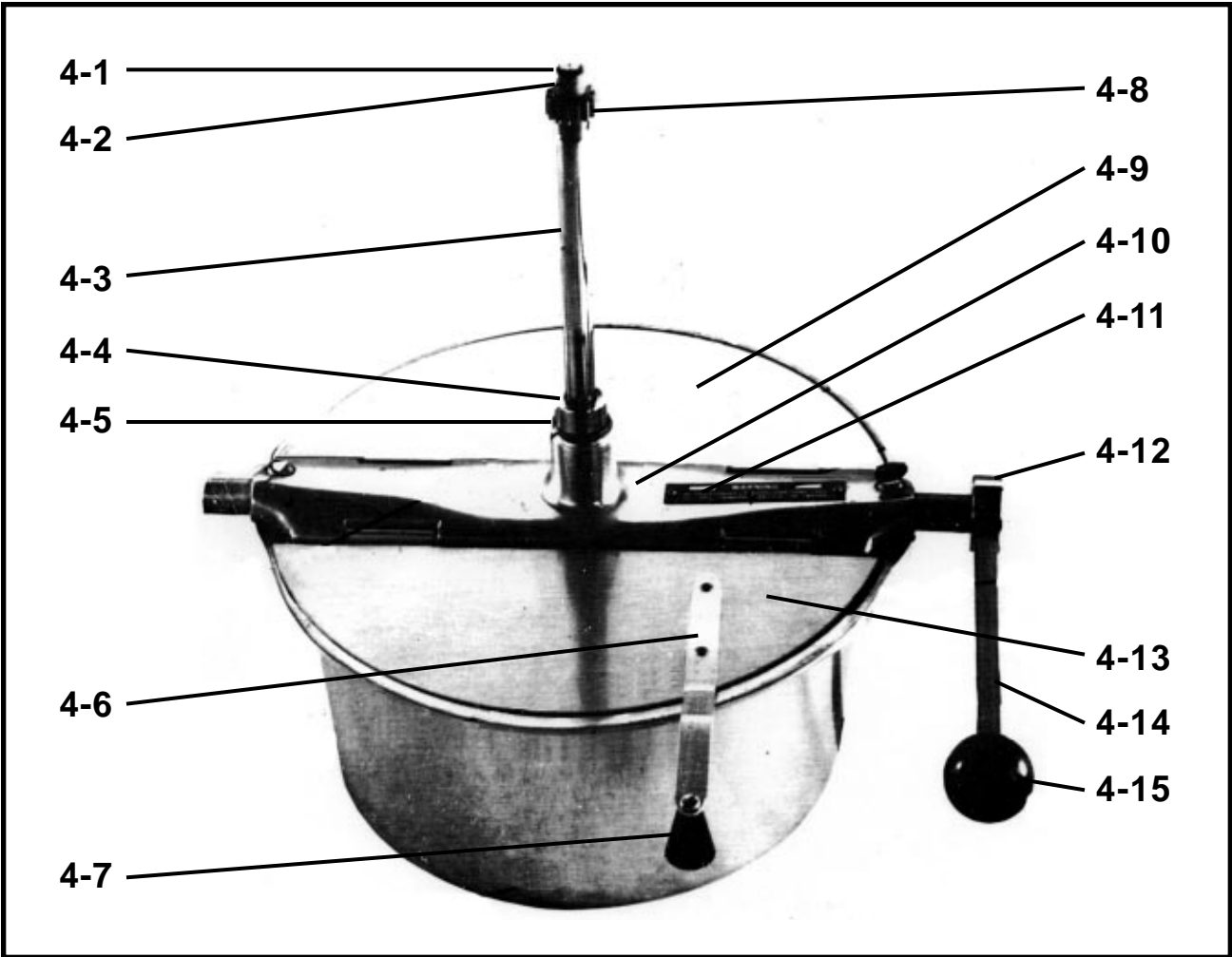

PARTS LIST - KETTLE BOTTOM VIEW

Item No.	Part No.	Description
5-1	47393	Junction Box, Kettle
5-2	47394	Cover, Junction Box
5-3	47867	Kettle Lead Assembly
	47876	Plug Assembly
5-4	47087	Thermostat Retainer
5-5	47085	Heat Element Retainer
5-6	47082	Thermostat
5-7	47216	Shunt Bar (2 Required)
5-8	47375	Kettle Shell
5-9	47752	Kettle Casting
5-10	47089	Heat Element, 660 Watt
5-11	47051	Kettle Stud with Nuts (4 Required)
5-12	47285	Solid Kettle Wire
5-13	47090	Heat Element, 1050 Watt
	47882	Kettle Bottom Only
	47883	Kettle Complete

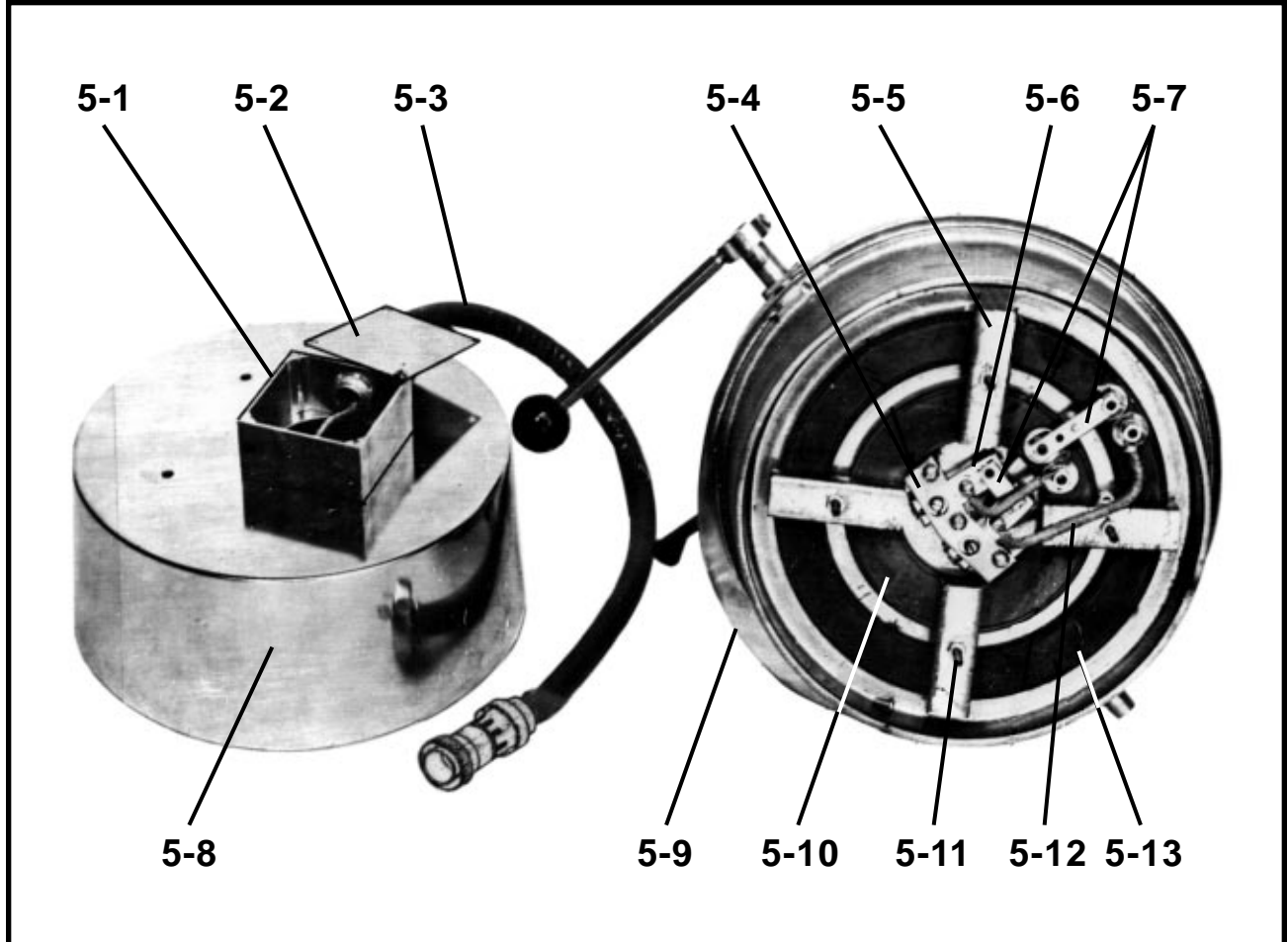

PARTS LIST - 28" POPCORN CART

Manufactured before 8/88	Manufactured after 8/88	Description
Part No.	Part No.	
13170	13170	Fastener Pack
47530	47530	Handle
47532	47532	Leg Support Bracket, Red
47534	47534	Leg, Red
47537	47537	Leg Tie Strip, Red
47538	47538	Bracket, Handle Bar
47533	52032	Axle
47540	54063	Front Axle Mount Bracket, Red
47541	54064	Rear Axle Mount Bracket, Red
37033	37033	Strip Grommet
47000	47000	Warranty Registration Card
47535	47535	Base Assembly, Red
47539	47539	Shipping Carton
47552	47552	Nameplate
47713	47713	Instruction Sheet
47748	47748	Label, N.S.F.
47527	52030	Wheel, 24" Yellow
76242	76242	M.E.A. Dataplate

PARTS LIST - 4 WHEEL WAGON

Manufactured before 8/88	Manufactured after 8/88	Description
Part No.	Part No.	
13136	13136	Shipping Carton
13171	13171	Fastener Pack
47530	47530	Handle
47538	47538	Bracket, Handle Bar
47579	47579	Tie Plate, Red
47533	52032	Axle
47540	54063	Front Axle Mount Bracket, Red
47541	54064	Rear Axle Mount Bracket, Red
47000	47000	Warranty Registration Card
47573	47573	Base Assembly, Red
47648	47648	Packing Inserts
47686	47686	Counter Top, Formica
47713	47713	Instructon Sheet, Carts
47527	52030	Wheel, 24" Yellow
76242	76242	M.E.A. Dataplate

ELECTRICAL SCHEMATIC

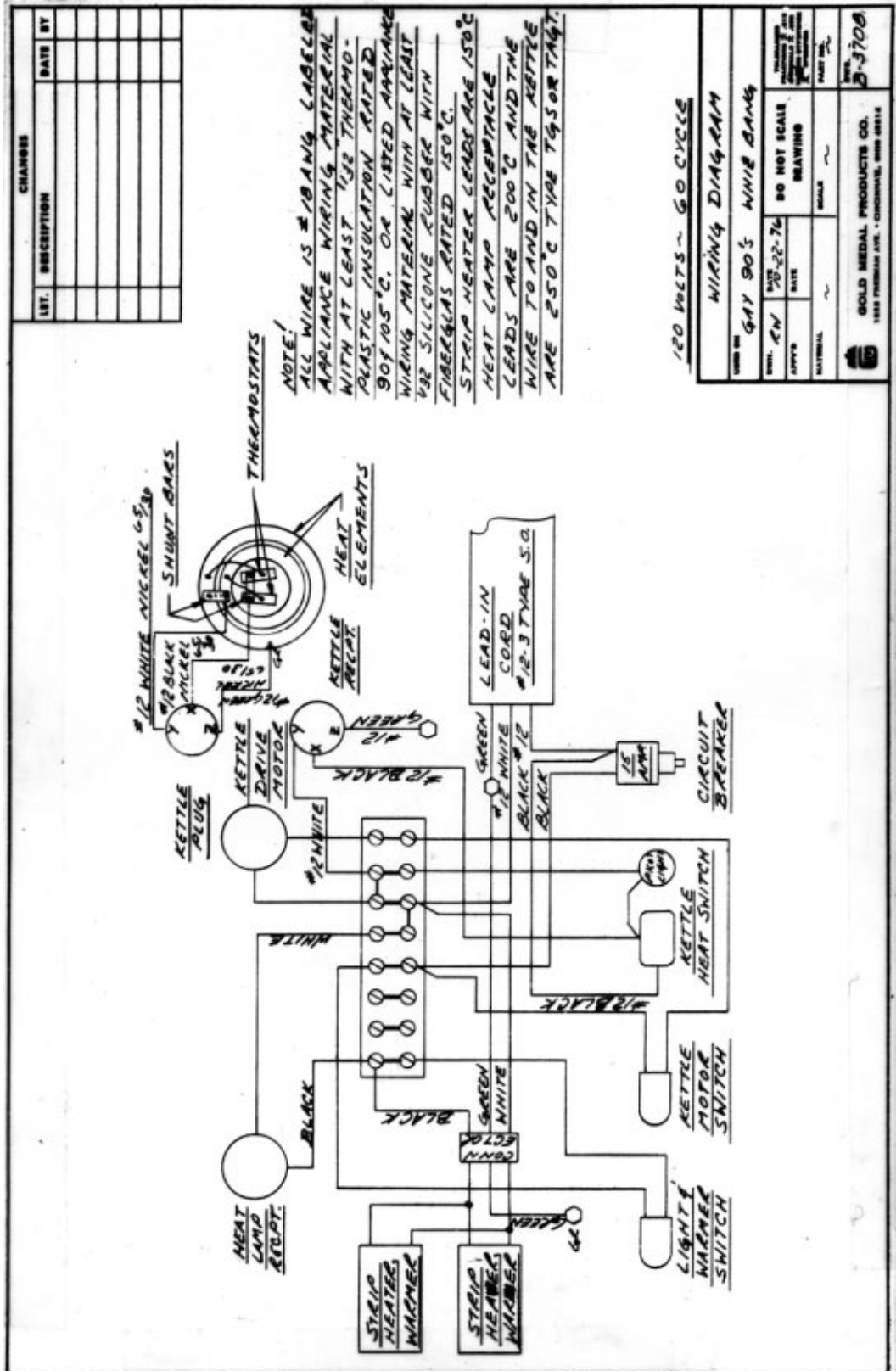

WARRANTY

WE WARRANT to the original purchaser the Gold Medal equipment sold by us to be free from defects in material or workmanship under normal use and service. Our obligation under this warranty shall be limited to the repair or replacement of any defective part for a period of six (6) months from the date of sale to the Original Purchaser with regard to labor and two (2) years with regard to parts and does not cover damage to the equipment caused by accident, alteration, improper use, voltage, abuse, or failure to follow instructions.

THIS WARRANTY IS IN LIEU OF ALL OTHER WARRANTIES EXPRESSED OR IMPLIED, AND OF ALL OTHER OBLIGATIONS OR LIABILITIES ON OUR PART, INCLUDING THE IMPLIED WARRANTY OF MERCHANTABILITY. THERE ARE NO WARRANTIES WHICH EXTEND BEYOND THE DESCRIPTION ON THE FACE HEREOF. We neither assume, nor authorize any other person to assume for us, any other obligation or liability in connection with the sale of said GOLD MEDAL equipment or any part thereof.

The term "Original Purchaser" as used in this warranty shall be deemed to mean that person, firm, association, or corporation who was billed by the GOLD MEDAL PRODUCTS COMPANY, or their authorized distributor for the equipment.

THIS WARRANTY HAS NO EFFECT AND IS VOID UNLESS THE ORIGINAL PURCHASER FIRST CALLS GOLD MEDAL PRODUCTS COMPANY AT 1-800-428-2676 TO DISCUSS WITH OUR SERVICE REPRESENTATIVE THE EQUIPMENT PROBLEM, AND, IF NECESSARY, FOR INSTRUCTIONS CONCERNING THE REPAIR OR REPLACEMENT OF PARTS.

NOTE: This equipment is manufactured and sold for commercial use only.



GOLD MEDAL PRODUCTS COMPANY
10700 Medallion Drive
Cincinnati, Ohio 45241-4807 USA